



# More Precision

**wireSENSOR** // Draw-wire displacement sensors



- Extreme compact miniature sensor
- Flexible mounting via swivel flange
- High speed measurement, wire acceleration up to 100g



Model MPM

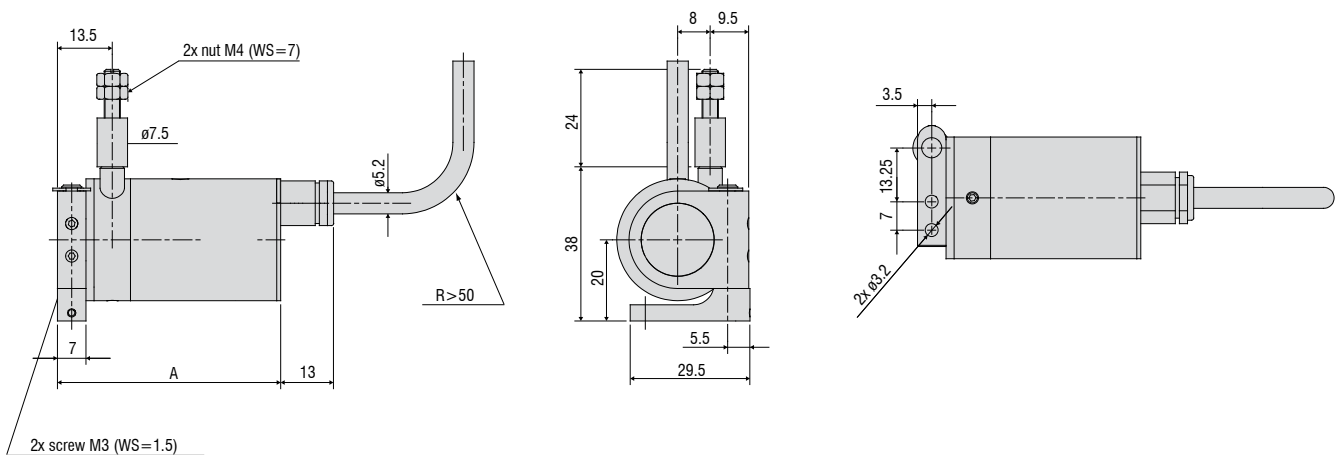

Measuring range (mm)	A (mm)
50	55
150 / 250	64
50-HG	61
150 / 250-HG	70

Model	WDS-50-MPM	WDS-150-MPM	WDS-250-MPM
Output	P		
Measuring range	50mm	150mm	250mm
Linearity	±0.2% FSO	-	±0.3mm
	±0.25% FSO	±0.125mm	-
Resolution	towards infinity		
Sensor element	conductive plastic potentiometer	hybrid potentiometer	
Temperature range	-20 °C ... +80 °C		
Material	housing	aluminum	
	draw-wire	stainless steel (ø 0.45mm)	
Sensor mounting	swivel flange in two axes 180° / 360°		
Wire mounting	thread M4		
Wire acceleration	approx. 25g (option HG: 100g)		
Wire retraction force (min)	1.5N (option HG: 10N)		
Wire extension force (max)	3.5N (option HG: 17N)		
Protection class	IP65		
Vibration	20g, 20Hz - 2kHz		
Mechanical shock	50g, 20ms		
Electrical connection	integrated cable, axial, 3-leads, 1m		
Weight	approx. 150g		

FSO = Full Scale Output  
 Specifications for analog outputs on page 51.

#### Article description

WDS -	50 -	MPM -	C -	P -	HG
					Option HG: wire acceleration up to 100g
					Output option: P: potentiometer
					Connection: C: integrated cable, axial, 1m
					Model MPM
					Measuring range in mm

**Accessories:**

WE-xxx-M4	Wire extension with M4-wire connection, x=length
WE-xxx-Clip	Wire extension with eyelet, x=length
TR1-WDS	Pulley wheel, adjustable
TR3-WDS	Pulley wheel, fixed
GK1-WDS	Attachment head for M4
MH1-WDS	Magnetic holder for wire mounting
MH2-WDS	Magnetic holder for sensor mounting
MT-60-WDS	Mounting clamp for WDS-P60
FC8	Female connector for WDS, 8-pin
FC8/90	Female connector 90° for WDS
PC 3/8-WDS	Sensor cable, length 3m
PS 2020	(Power Supply 24 V / 2,5 A, Input 100 - 240 VAC, output 24 VDC / 2.5 A, for snap in mounting on DIN 50022 rail)
WDS-MP60	Mounting plate for P60 sensors

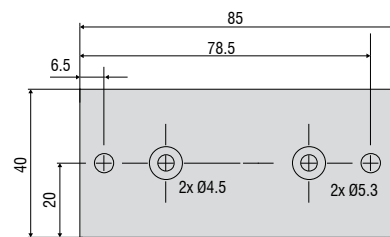
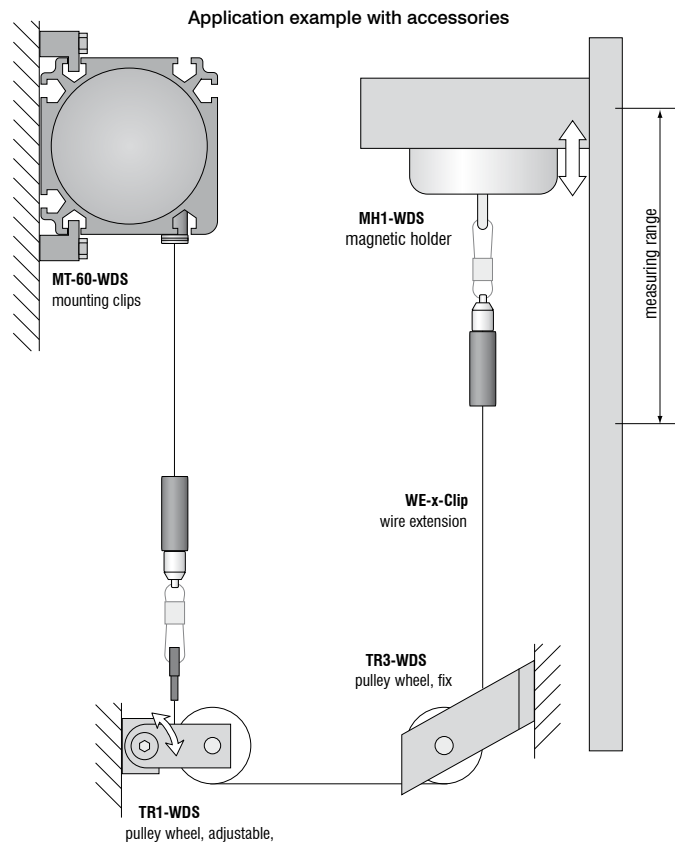

Mounting plate WDS-MP60

**Installation information:**

**Wire attachment:** The free return of the measurement wire is not permissible and it is essential that this is avoided during installation.

**Wire exit angle:**

When mounting a draw-wire displacement sensor, a straight wire exit ( $\pm 3^\circ$  tolerance) must be taken into account. If this tolerance is exceeded, increased material wear on the wire and at the wire aperture must be expected.

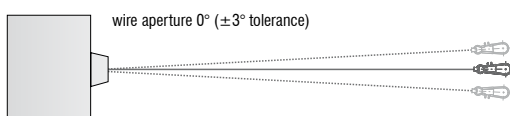

Output	Plug M16 -SA / -SR	Integrated cable -CA / -CR	Open contacts
--------	-----------------------	-------------------------------	---------------

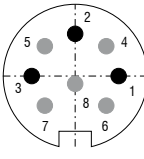
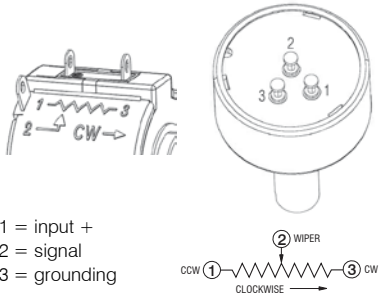
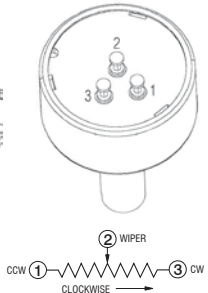
Potentiometric output (P)				
Supply voltage	max. 32VDC at 1kOhm / 1 Wmax	 <p>sensor side</p>	white = input + brown = grounding green = signal	
Resistance	1kOhm ±10% (potentiometer)			
Temperature coefficient	±0.0025% FSO/°C			
		1 = input + 2 = grounding 3 = signal	1 = input + 2 = signal 3 = grounding	

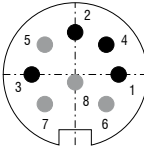
Voltage output (U)				
Supply voltage	14 ... 27VDC (non stabilized)	 <p>sensor side</p>	white = supply brown = grounding green = signal yellow = ground	
Current consumption	max. 30mA			
Output voltage	0 ... 10VDC Option 0 ... 5 / ±5V			
Load impedance	>5kOhm			
Signal noise	0.5mV <sub>eff</sub>			
Temperature coefficient	±0.005% FSO/°C			
Electromagnetic compatibility (EMC)	EN 61000-6-4 EN 61000-6-2			
<b>Adjustment ranges</b> (if supported by the model)		1 = supply 2 = grounding 3 = signal 4 = ground		
Zero	±20% FSO			
Sensitivity	±20%			

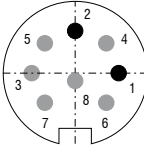
Current Output (I)				
Supply voltage	14 ... 27VDC (non stabilized)	 <p>sensor side</p>	white = supply brown = grounding	
Current consumption	max. 35mA			
Output current	4 ... 20mA			
Load	<600Ohm			
Signal noise	<1,6 μA <sub>eff</sub>			
Temperature coefficient	±0.01% FSO/°C			
Electromagnetic compatibility (EMC)	EN 61000-6-4 EN 61000-6-2			
<b>Adjustment range</b> (if supported by the model)		1 = supply 2 = grounding		
Zero	±18% FSO			
Sensitivity	±15%			

## High performance sensors made by Micro-Epsilon



Sensors and systems for displacement and position



Sensors and measurement devices for non-contact temperature measurement



2D/3D profile sensors (laser scanner)



Optical micrometers, fiber optic sensors and fiber optics



Color recognition sensors, LED analysers and color inline spectrometer



Measurement and inspection systems