



More Precision.

reflectCONTROL Sensor // 3D measurements & inspection of shiny surfaces





- Measurement of shiny, flat components
- Fast, full-surface inspection
- High-precision measurement, flatness deviation in the submicron range
- Large measuring field

RCS130 deflectometry sensor for 3D measurements of shiny surfaces

reflectCONTROL is intended for shape measurements of shiny objects. This sensor displays a striped pattern which is mirrored by the surface of the measuring object into the sensor cameras. The sensor provides a 3D image of the surface which allows for the topology of the components (e.g. flatness, deflection, curvature) to be determined. The RCS130 model is specially optimized for measurement and inspection tasks, e.g., in production lines. Moreover, the sensor has a GigE Vision interface that offers GenICam compliant data.

Application examples:

- Semiconductor industry:
 - Wafer flatness measurement
- Electronics industry:
 - Tablet PCs, display glasses, etc.
- Automotive:
 - Mirrors for head-up displays
- General:
 - Mirrors for technical applications

3D shape measurement of smartphone display and wafer (Ø 150 mm)

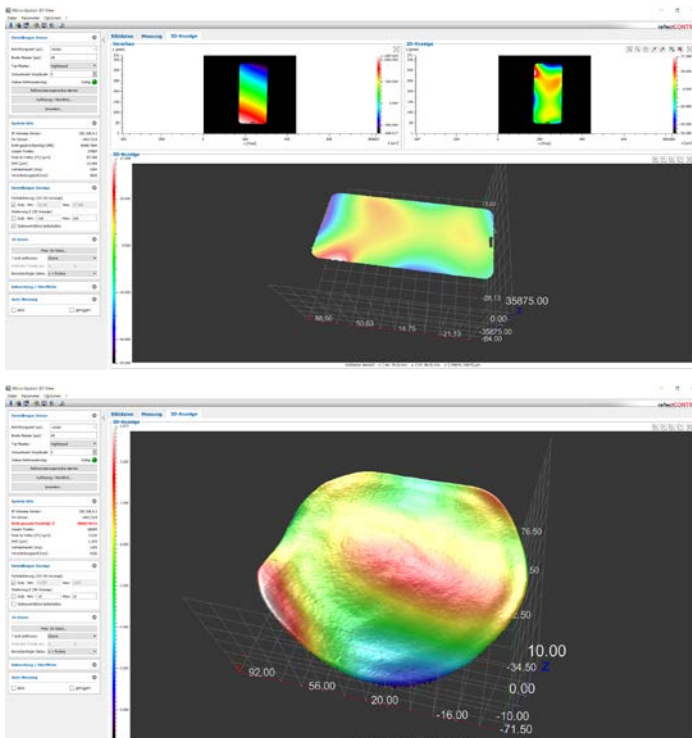

Model	RCS130-060	RCS130-160
Measuring range Length x width (x * y) ¹⁾ in reference plane	60 mm x 50 mm	170 mm x 160 mm
Acquisition of measurement data	approx. 1.2 s ... 6 s	
Evaluation	approx. 2 s ... 8 s	
Resolution x, y	30 μm	100 μm
Flatness deviation z ²⁾	< 1 μm	
Supply voltage	24 V DC (must not exceed 26 V)	
Power consumption	< 50 W	
Interfaces and connections	1 x GigE Vision (RJ45), 1 x Ethernet (RJ45), power supply (3-pin Lemo connector)	
Mounting	mechanically reproducible adapter flange	
Temperature range	Storage	-10 ... 60 °C
	Operation ²⁾	0 ... 40 °C (for 3D measurements: max. fluctuation of ± 2 °C after referencing)
Humidity ²⁾	10 ... 80 %, non-condensing (for 3D measurements: max. fluctuation of ± 2 °C after referencing)	
Design	carbon housing with controlled fan, design with integrated controller	
Weight	< 7 kg	

¹⁾ Size specifications refer to the reference plane. Trapezoidal measuring field - the medium width is specified. For exact dimensions see figure.

²⁾ Measured after referencing with a plane mirror (\varnothing 300 mm) and a flatness of $\lambda/10$ at a max. distance tolerance of ± 0.1 mm.

After referencing, a maximum temperature fluctuation of ± 2 °C and change of humidity of ± 2 % are to be complied with.

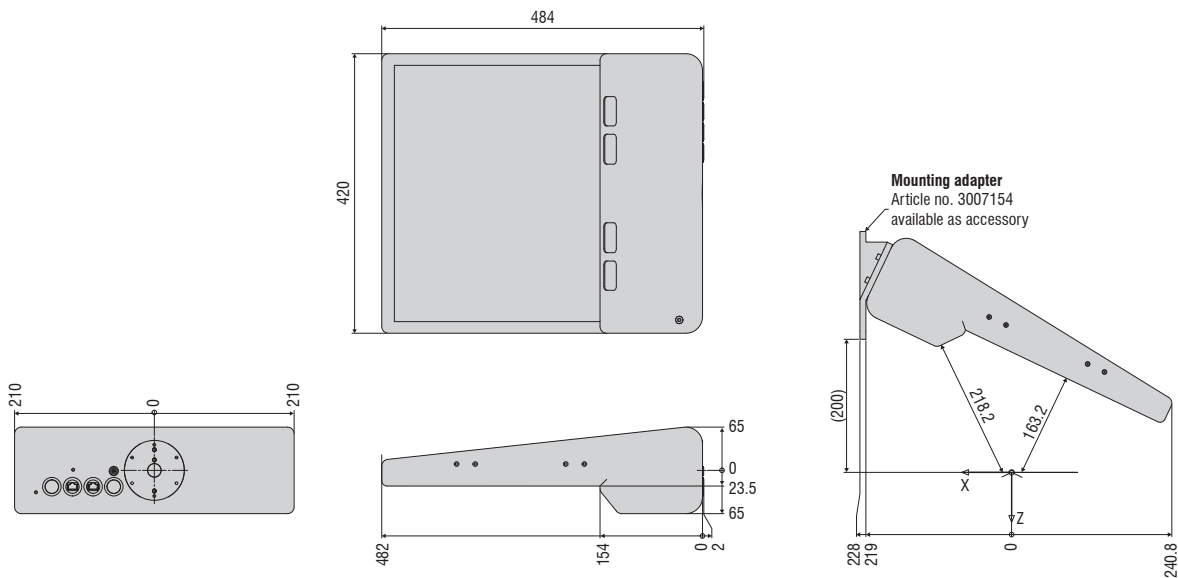

Measuring field RCS130-060

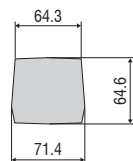

Measuring field RCS130-160

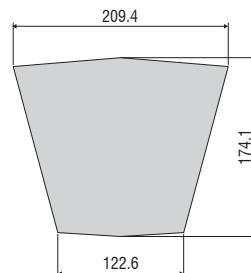



- Inspection of shiny surfaces, defect detection
- Cost savings due to reduced defect slippage compared to visual inspection

RCS110-245 - Surface inspection of shiny components

reflectCONTROL is intended for surface inspection of shiny objects. The RCS110-245 model with integrated controller is available for stationary measurements or integration into machines. This compact sensor displays a striped pattern which is mirrored by the surface of the measuring object into the sensor cameras. Deviations on the surface will cause deviations from this striped pattern, which are evaluated by software and displayed as a curvature image. GigE Vision enables the transfer of surface images to a wide range of image processing software packages for further analyses.

reflectCONTROL Automation for fully automated surface inspection

For fully automated surface inspection tasks and defect detection of larger components, the robot-based and complete reflectCONTROL Automation system is available. The sensor attached to the robot is guided to the relevant areas for surface inspection. The comprehensive software package includes all required tools from measurement configuration and evaluation to the display of detected defects superimposed on the CAD model of the component.

Application examples:

- Automotive industry:
 - Attachments, interior parts
- Electronics industry:
 - Smartphone housing, etc.
- Injection-molded and painted parts

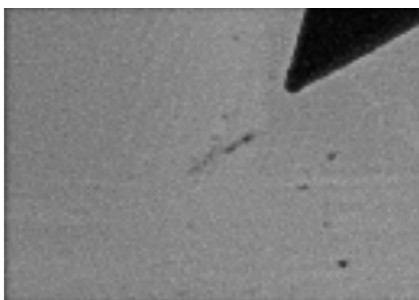

Reflectivity image

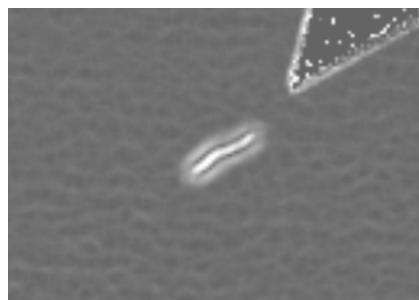

Curvature image

Model	RCS110-245	
Measuring range Length x width (x * y) ¹⁾ in reference plane	116 mm x 245 mm	
Acquisition of measurement data	approx. 0.6 s ... 2.7 s	
Evaluation	approx. 0.5 s ... 2.4 s	
Resolution	x, y	70 μm
Supply voltage	24 V DC (must not exceed 26 V)	
Power consumption	< 50 W	
Interfaces and connections	1 x GigE Vision (RJ45), 1 x Ethernet (RJ45), power supply (3-pin Lemo connector)	
Mounting	mechanically reproducible adapter flange	
Temperature range	Storage	-10 ... 60 °C
	Operation	0 ... 40 °C
Humidity	10 ... 80 %, non-condensing	
Design	carbon housing with controlled fan, design with integrated controller	
Weight	< 7 kg	

¹⁾ Size specifications refer to the reference plane. The medium width is specified. For exact dimensions see figure.

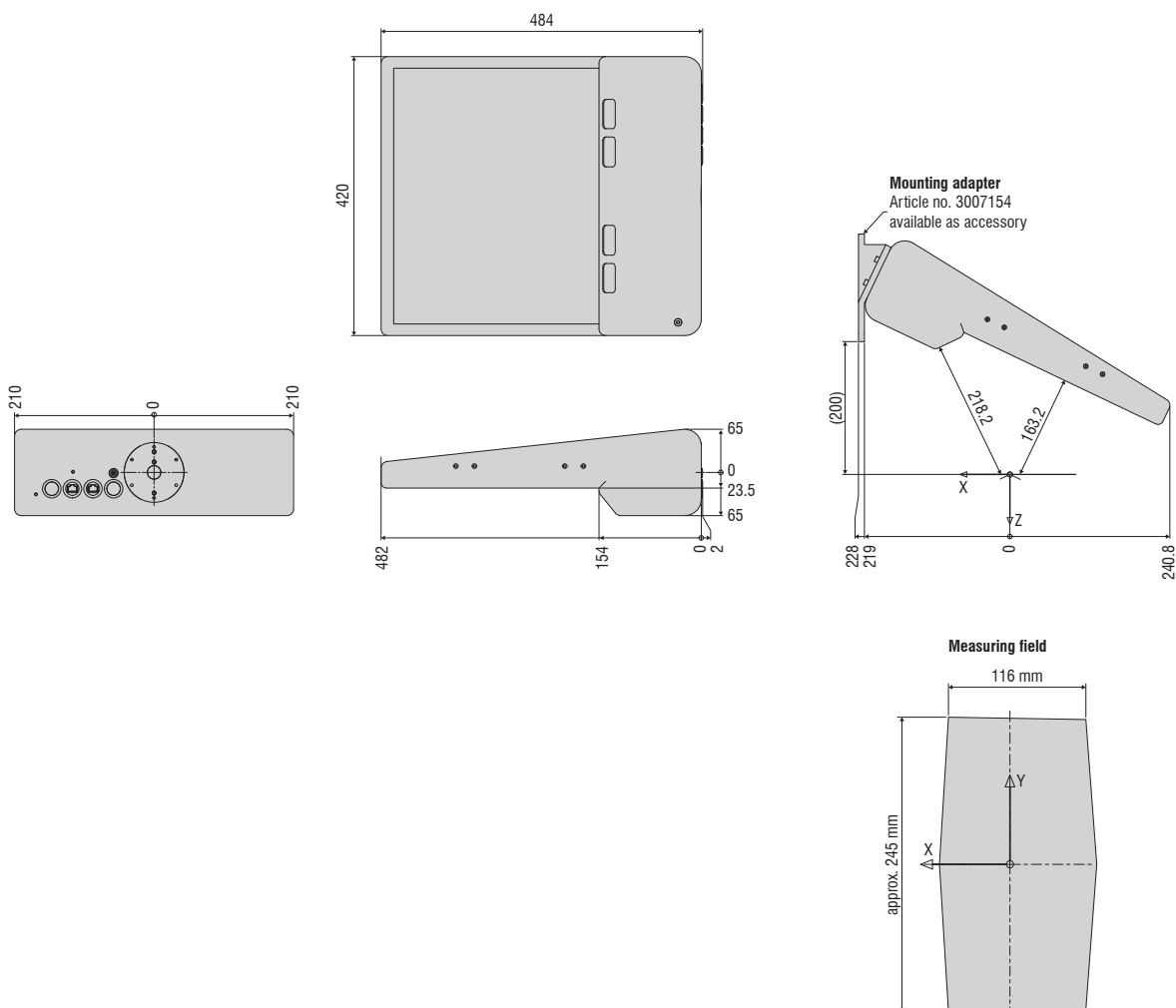

3DInspect

3DInspect is a powerful tool for sensor parameter set up and industrial measurement tasks.

The software can also be used to start data acquisition. The 3D data obtained is visualized and can be exported in different file formats (ASCII, CSV, STL, PLY) for further processing.

In addition, reflectCONTROL sensors can be referenced with a plane standard (plane mirror). The software also enables pre-processing of the data obtained (e.g. planarity fit) and to directly output the data as PV and RMS values.

3DInspect is particularly helpful for system integrators as it provides important information: They can access all GenICam parameters, which considerably simplifies the integration of the software. For inline applications, the display of the measurement duration allows conclusions to be drawn about the cycle time.

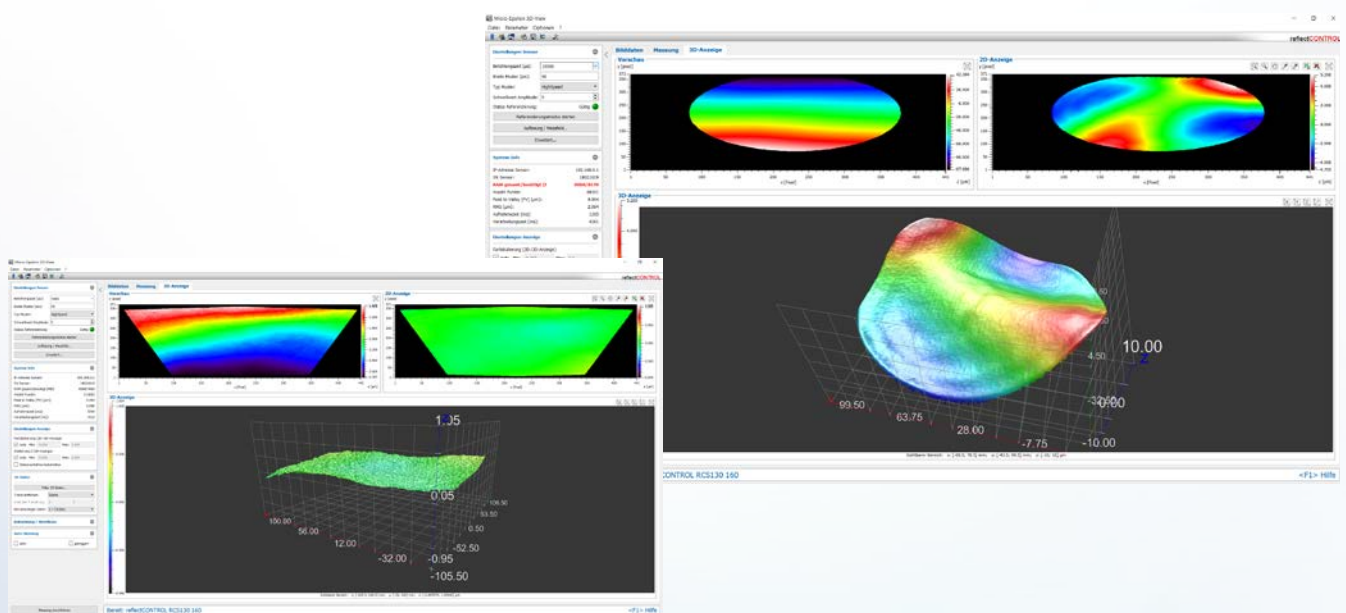

Software integration via Micro-Epsilon's 3D-SDK

reflectCONTROL is equipped with an easy-to-integrate SDK (Software Development Kit). The SDK is based on the GigE Vision and GenICam industry standards including the following function blocks:

- Network configuration and sensor connection
- Comprehensive sensor control
- Control of measurement data transfer (3D data, video images, ...)
- Management of user-defined parameter sets
- C++ example programs and documentation

Accessing the sensor via GigE Vision is also possible without SDK if you have a GenICam client.

Innovative 3D technology for high precision inspection and measurement of surfaces

Micro-Epsilon offers innovative 3D systems for a variety of measurement and inspection tasks on matt and shiny surfaces. They are used for both offline analysis and fully-automated operation on the robot.

These systems detect defects and perform precise geometrical measurements.



scanCONTROL

- Detection of profile, width, height, depth, angle, roundness, presence, flatness
- Red laser & patented Blue Laser Technology
- Up to 2048 points per profile
- Measuring rates up to 10,000 kHz
- Real-time surface compensation

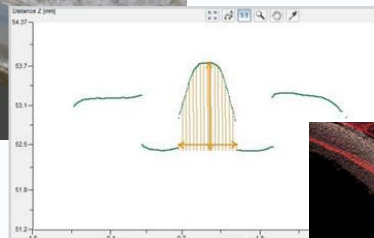
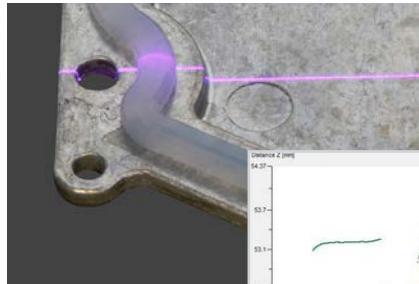

Profile measurement of small parts

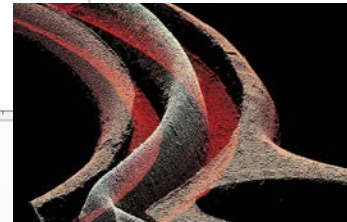

surfaceCONTROL

- Inspection of matt surfaces
- Reliable detection of surface deviations from 5 µm
- Reliable measurement of strong curvatures
- Optical error marking with back projection
- Inspection of both small and large objects

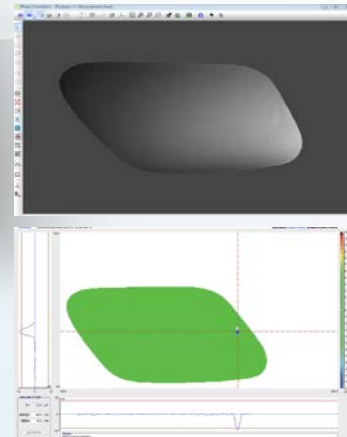

Inspection of exterior plastic parts

surfaceCONTROL 3D 3500

- Automated 3D inline inspection of shapes and surfaces on diffuse reflecting surfaces
- Highest precision in z up to <math>< 0.4 \mu\text{m}</math>
- Complete 3D images from 0.2 s
- Micrometer-accurate snapshots with large measuring fields
- High compatibility via different interfaces

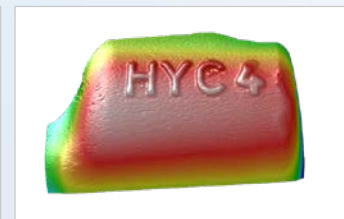
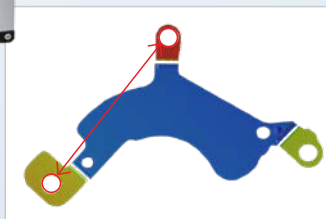

High-precision 3D measurements of small components

Sensors and Systems from Micro-Epsilon



Sensors and systems for displacement, distance and position



Sensors and measurement devices for non-contact temperature measurement



Measuring and inspection systems for metal strips, plastics and rubber



Optical micrometers and fiber optics, measuring and test amplifiers



Color recognition sensors, LED analyzers and inline color spectrometers

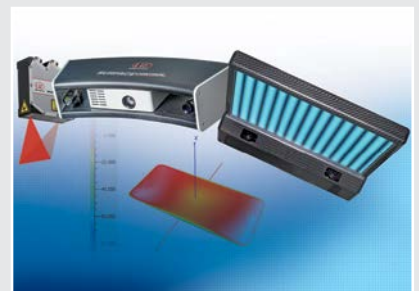

3D measurement technology for dimensional testing and surface inspection