

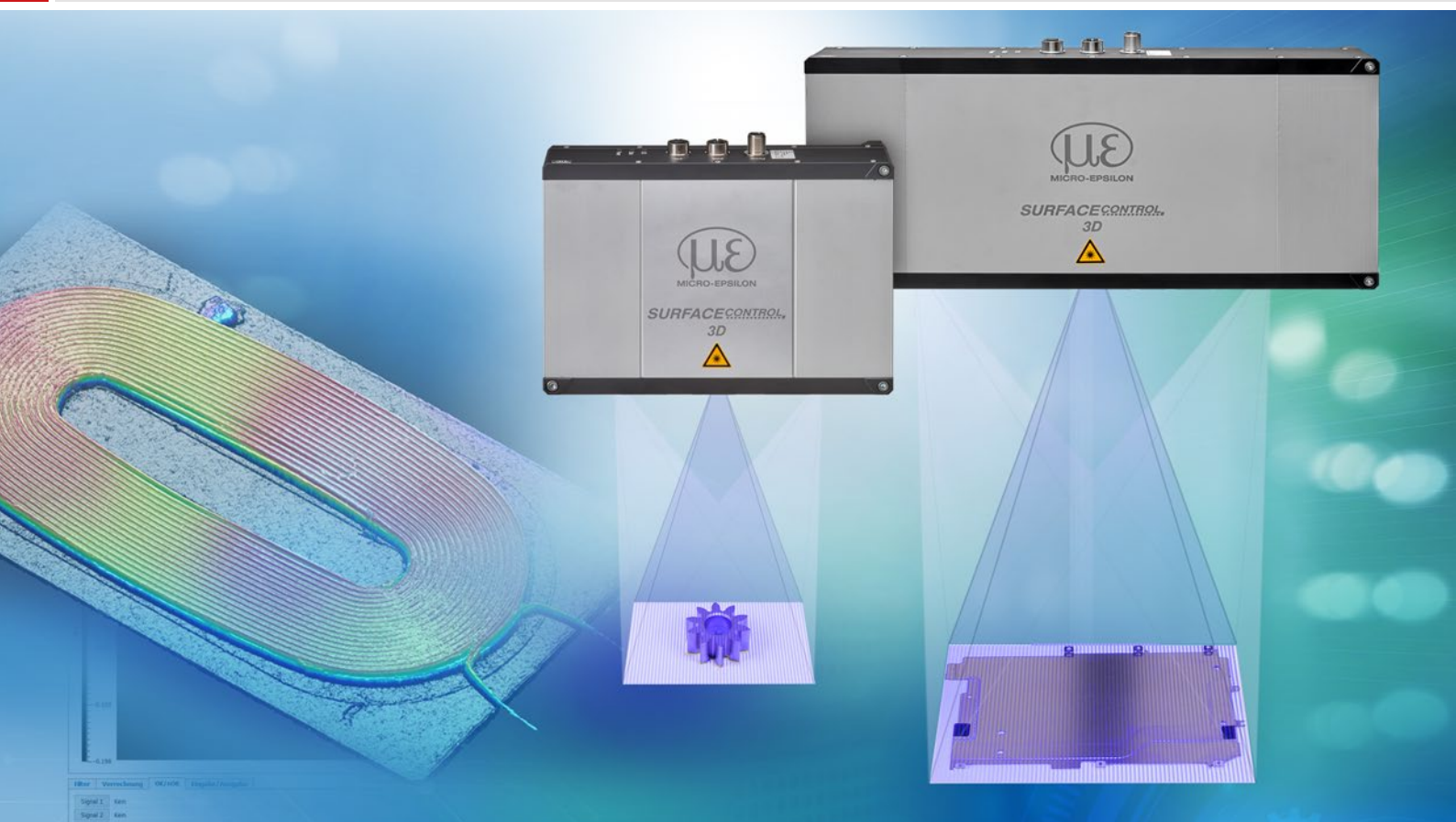

More Precision

surfaceCONTROL 3D // 3D sensors for geometry, shape and surface inspections



Precise sensor for 3D measurements and surface inspections

surfaceCONTROL 3D

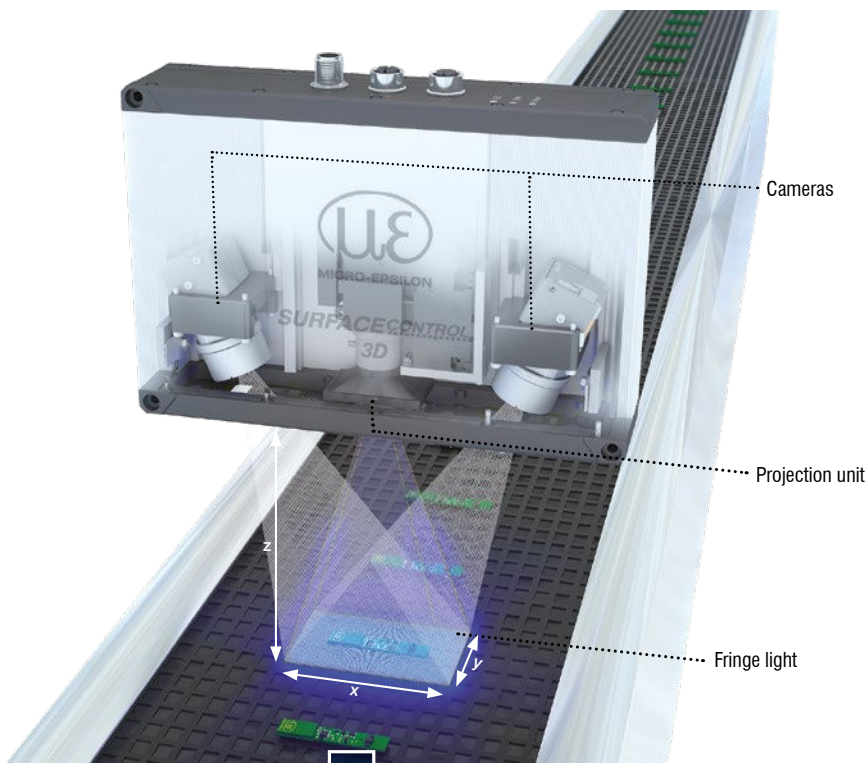

Measuring principle

The surfaceCONTROL 3D sensors work according to the principle of optical triangulation based on fringe projection. Using a matrix projector, a sequence of patterns is projected onto the test object surface. The light of the patterns diffusely reflected by the test object surface is captured by two cameras. The three-dimensional surface of the test object is then calculated from the recorded image sequence and the knowledge of the arrangement of the two cameras to each other.

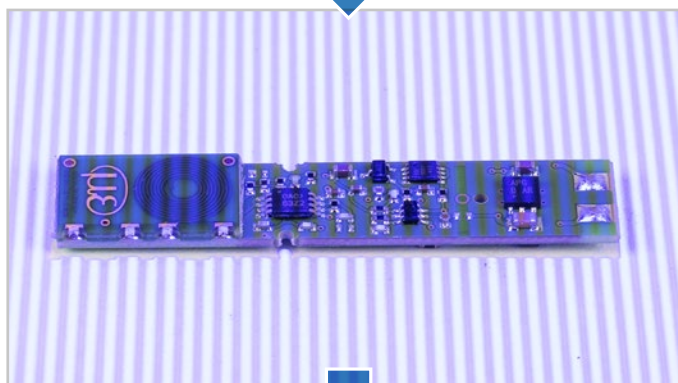

Measuring object with fringe light

surfaceCONTROL 3D sensors for inline 3D measurement tasks

surfaceCONTROL 3D sensors use individual snapshots to detect objects. The fast measurement combined with high data density allows use in 100% in-line testing during the production process. The superiority of surfaceCONTROL 3D sensors lies in their ability to detect the entire surface in a fraction of a second. The sensors generate a digital 3D image of the entire measuring object and provide significantly more detailed quality information than tactile measurement methods, for example.

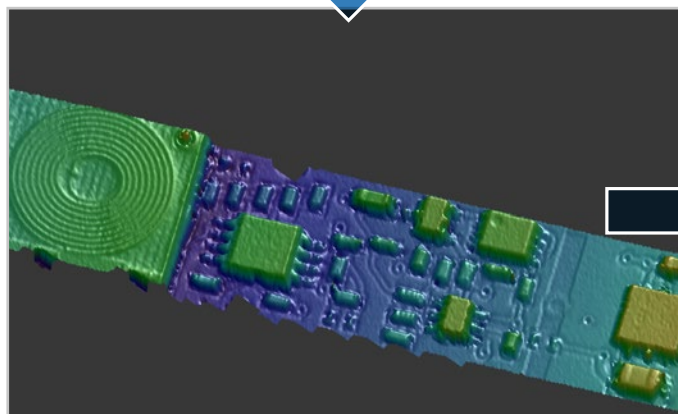

Detailed 3D display due to extremely high z-axis resolution

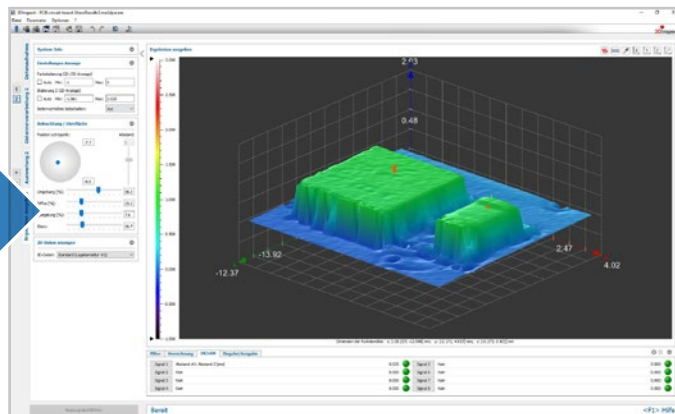

Automated evaluation in Micro-Epsilon software

Content / Model	Description	Page
surfaceCONTROL	Advantages and special features	4 - 7
surfaceCONTROL	Application examples	8 - 9
surfaceCONTROL 32x0	Powerful 3D sensors for industrial measurement tasks	10 - 11
surfaceCONTROL 35x0	High performance 3D sensors for industrial environments	12- 13
surfaceCONTROL	Dimensions and measurement areas	14 - 15
Software	surfaceCONTROL 3DInspect	16 - 17
Accessories	<ul style="list-style-type: none"> ▪ 2D/3D Gateway ▪ Industrial Performance Unit ▪ Cooling housing ▪ Connection cable 	18 - 19

The surfaceCONTROL 3D sensors provide a wide range of different measurement areas from 30 x 18.5 mm to 240 x 150 mm. The variety of measurement areas allows the detection of the smallest details and structures as well as of large objects at a large working distance and with high precision.

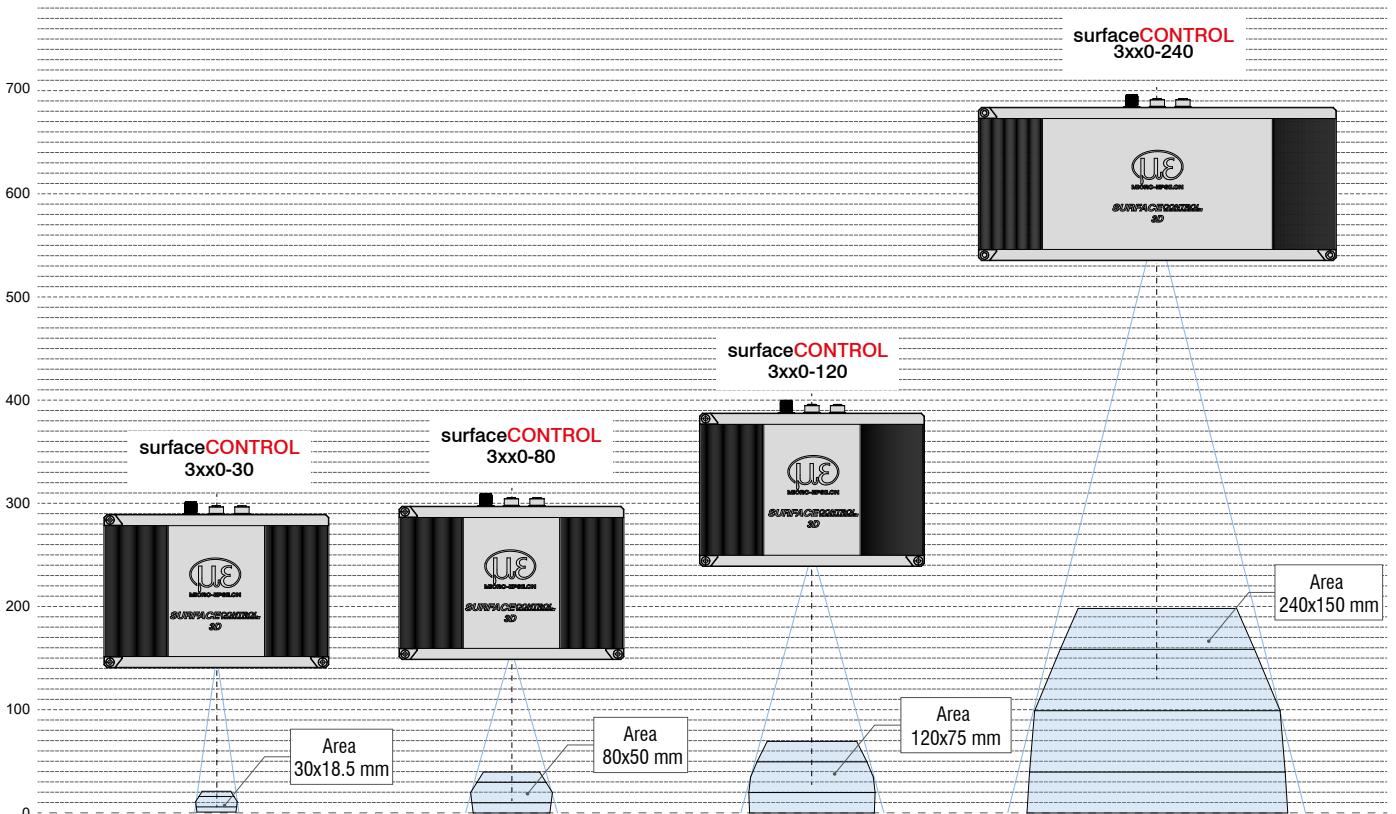

Precise sensor for 3D measurements and surface inspections

surfaceCONTROL 3D

- Highest z-axis repeatability up to 0.25 μm
- Automated inline 3D measurement for geometry, shape and surface inspections
- Up to 2.2 million 3D points / second
- Fully integrated industry sensor (IP67) with passive cooling
- Real 3D data via latest 3D GigE Vision standard
- Easy integration in all common 3D image processing packets



The new generation of high precision inline 3D measurements

The surfaceCONTROL 3D sensors are ideally suited to automated inline inspection of geometry, shapes and surfaces on diffuse reflecting surfaces. The sensors are characterized by their compact design and high measurement accuracy combined with high-speed data processing. With a z-axis repeatability of up to 0.25 μm , the surfaceCONTROL 3D sensors set new standards in high precision 3D measurement technology. This enables reliable detection of even the smallest deviations in flatness and height. Two models cover different measuring fields.

In addition to the fast data output via Gigabit Ethernet, the sensors offer an additional digital I/O interface. The 2D/3D Gateway II supports EtherNet/IP, PROFINET and EtherCAT connections. Powerful software tools enable precise 3D measurements and surface inspection. GigE Vision compatibility also allows easy integration into third-party image processing software. The comprehensive SDK for customer software integration rounds off the software package.



Advantages of surfaceCONTROL 3D sensors compared to 2D cameras

Conventional 2D cameras do not recognize depth information when capturing images. If the position of a measuring object changes, errors can occur during evaluation. The advantage of surfaceCONTROL 3D sensors lies in the high-precision measurement of height differences, which are visualized in color by the software. Due to the additional height information generated, the sensors automatically compensate for errors caused by changes in height. As a result, they work much more reliably than cameras, even for objects in different positions. In addition, the surfaceCONTROL 3D sensors have two integrated cameras that are optimally aligned and combine the captured points in a point cloud.

	2D	3D
Analysis of volume and/or shapes	✗	✓
Contrast information is well recognizable	✓	✓
Recognition of height variations	✗	✓
Positioning task / detection in the third dimension	✗	✓
Component identification	✓	✓
Presence monitoring of components	✓	✓
Damage detection	✓	✓

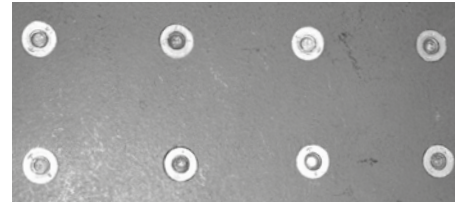

Gray image with a 2D camera image
No depth information through the camera image

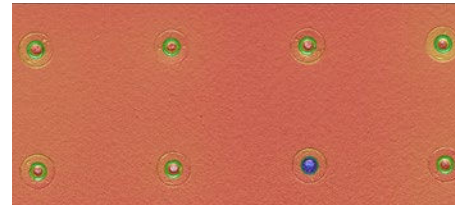
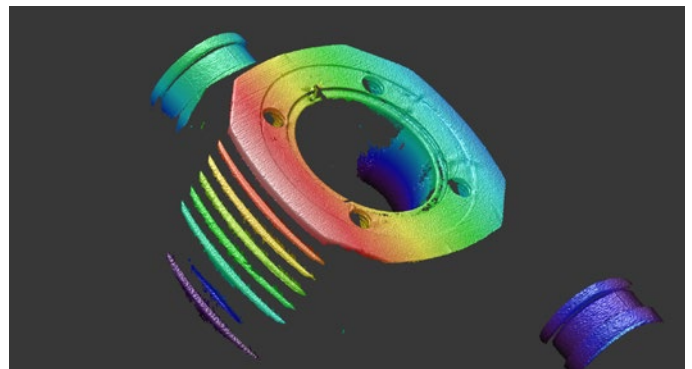

Image from a 3D sensor
Depth information and height deviations from the target value

Point clouds with up to 2.2 million 3D points per second

The surfaceCONTROL 3D achieves acquisition speeds of up to 2.2 million 3D points per second, each point of which has an x, y and z coordinate. This large number of measuring points, the so-called point cloud, is used to generate and visualize inventory data for subsequent analysis and evaluation. Point clouds can have information on reflection and color, and thus reproduce a realistic image. The subsequent processing of captured point clouds consists of generating point clouds of the individual viewpoints and linking them to form an overall point cloud.



New: high-precision sensor for tiny targets

With its small measurement area of 30 x 18.5 mm, the surfaceCONTROL 35x0-30 detects even the finest 3D and surface structures with utmost precision and reliability. Its high z-axis resolution and the precise repeatability make the 3D sensor the most precise on the 3D snapshot sensor market.

In addition, tiny objects with a working distance of 130 mm can be detected while the xy resolution from 16 μm ensures even more accurate detection.

New: large measurement area with excellent z-precision

With a measurement area up to 245 x 180 mm, the surfaceCONTROL 35x0-240 captures structures and details on larger targets with high precision. Due to their high z-axis measuring range of 240 mm, the sensors are ideal for applications with large measuring volumes. The high z-axis resolution of 4 μm in combination with the larger measurement area enables maximum precision for a wide range of applications, e.g. for testing bipolar plates for fuel cells.

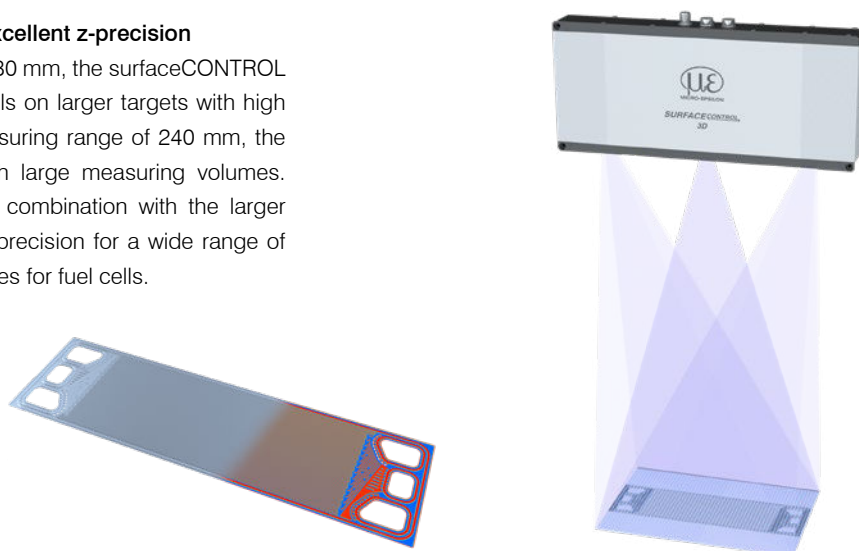

Precise sensor for 3D measurements and surface inspections

surfaceCONTROL 3D

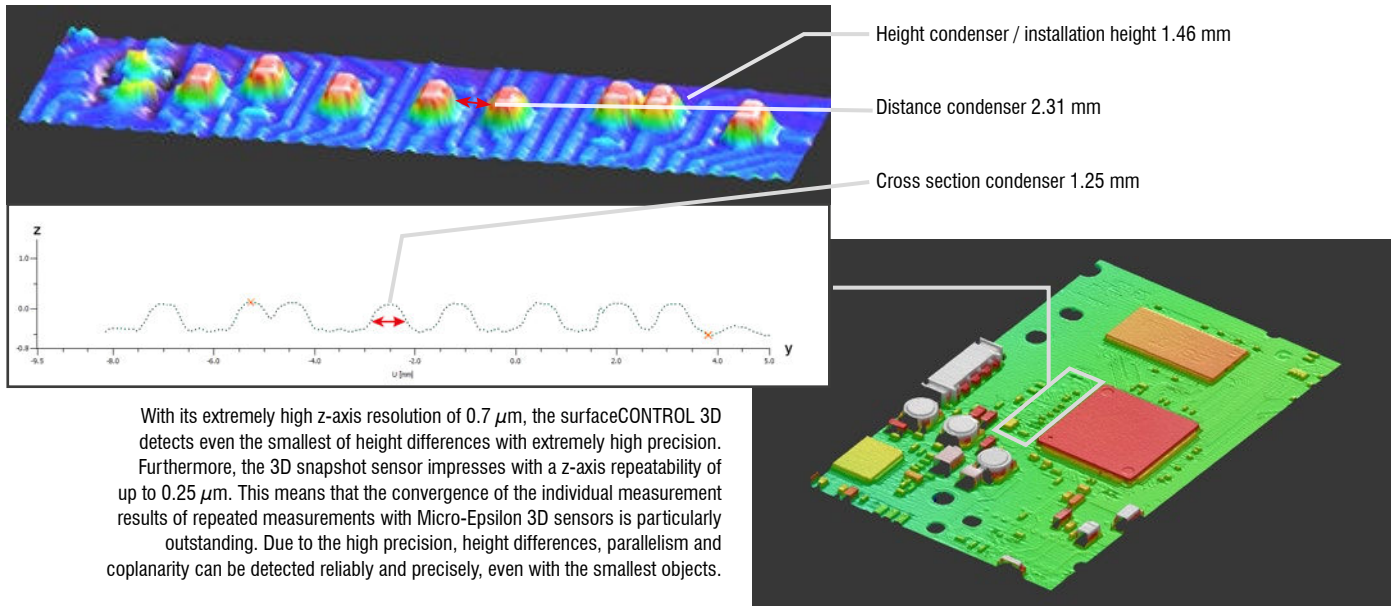

Precise raw data for integrators and image processors

The surfaceCONTROL 3D sensors from Micro-Epsilon are used for a variety of measurement and inspection tasks on matt surfaces. The results can be documented and compared. This allows for important conclusions to be drawn for process improvements. The sensors can be used in offline applications as well as in fully automated operation.

3D SDK at a glance:

- GigE Vision / GenICam compatible
- Access to all sensor parameters
- Examples included
- Comprehensive documentation

Software integration via Micro-Epsilon's 3D-SDK

3D sensors from Micro-Epsilon are equipped with a user-friendly SDK (Software Development Kit). The SDK is based on the GigE Vision and GenICam industry standards including the following essential function blocks:

- Network configuration and sensor connection
- Control of data transmission (3D measurement data, video images, profile counters, ...)
- Comprehensive sensor control
- User sets
- Documentation
- C++ example programs
- 3D Viewer



Automation technology in combination with 3D precision sensor technology

Robust hardware combined with an intelligent software concept makes the surfaceCONTROL 3D ideal for use in automation technology. Due to their compact design and low weight, the sensors can be easily mounted on robots and devices. The signal and supply cables are suitable for drag chains.

In factory automation, in autonomous assembly systems or in complex process monitoring - the surfaceCONTROL 3D sensors deliver the most precise results directly to the machine and system control due to their high precision, fast data processing speed and large number of interfaces.



Automatic 100% inline inspection at high speed

The surfaceCONTROL 3D sensors generate a 3D image of an area with just one shot and detect the position of the target underneath. It is therefore not necessary to position the measuring object on a precision measuring table. The 3D snapshots are created in fractions of a second without the need for time-consuming orientation of the measuring object. This reduces the measuring time and enables a 100% inspection in the production line as well as a good/bad evaluation of each individual object.

- Complete measurement with just one 3D snapshot
- No positioning of the measuring object required, automatic alignment by 3DInspect software
- New measurement during evaluation, short capture time thanks to high-resolution cameras

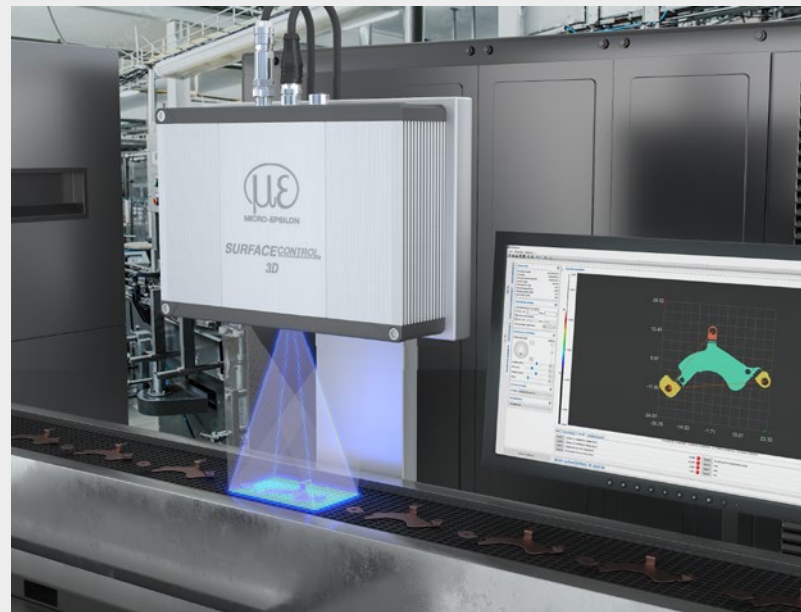

Simple and precise at-line inspection

The surfaceCONTROL 3D sensors provide a fast inspection solution for random tests during production. At-line processes are used either for the inspection of individual objects from the production line or for the inspection of defective parts at a special measuring station.

- Not necessary to orientate the target precisely
- Less measuring devices and equipment
- Avoids potential positioning errors

Application examples surfaceCONTROL 3D

Geometry and shape detection

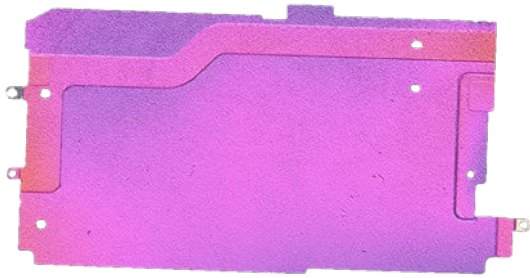

Flatness inspection of high-precision middle boards of smartphone carrier plates

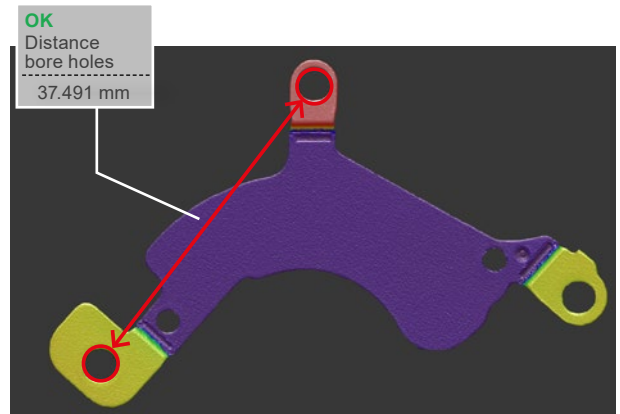

3D measurement of high precision mechanical parts: distance between the holes, planarity and coplanarity of mounting surfaces

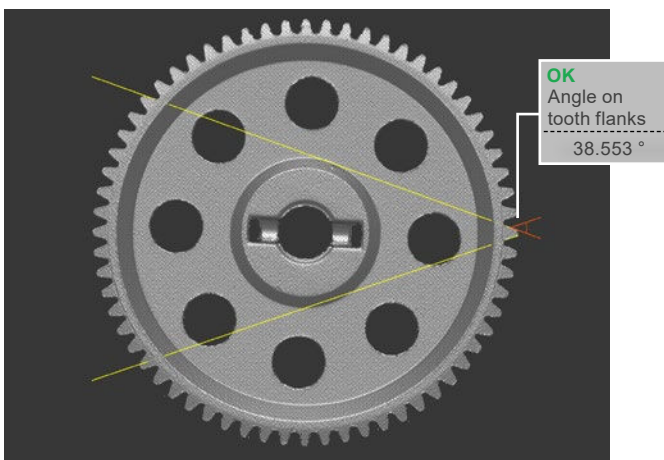

Angle on tooth flanks of a gear wheel

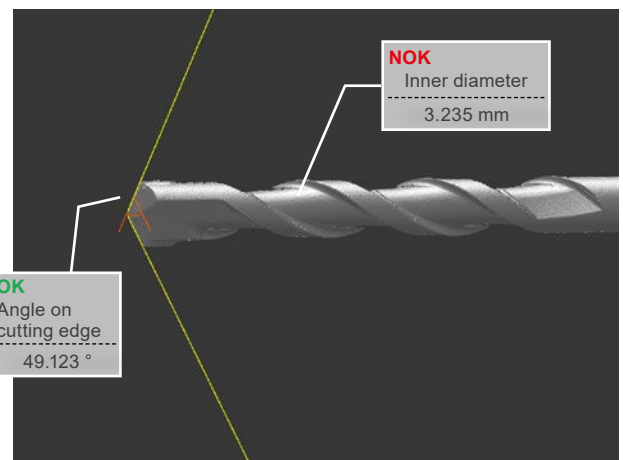

Measurement of the tip angle of the main cutting edge of a drill head and measurement of the internal diameter

Inspection of the smallest of components

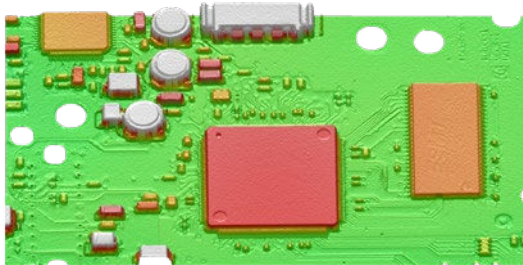

Completeness check of electronic components on fitted PCBs

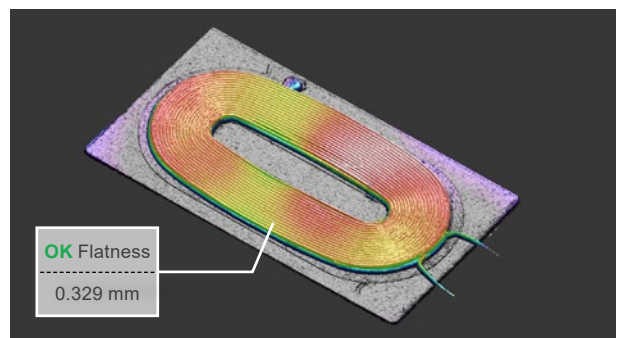

Flatness test of the winding on charging coils

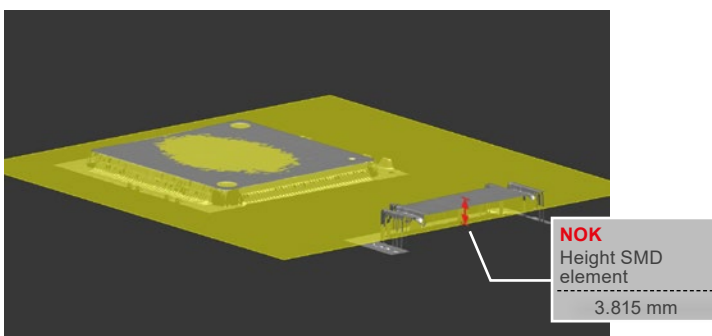

Monitoring of distance and plane-parallelism of assembled elements to each other and to the base surface (e.g. tombstone effect)

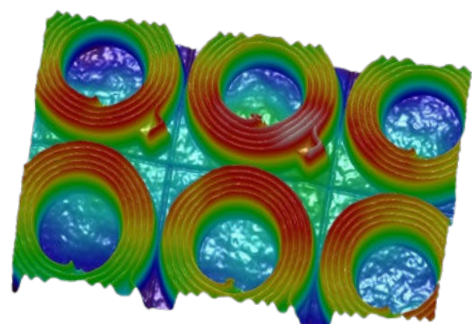

Planarity inspection of unpopulated PCB substrates

Defect detection

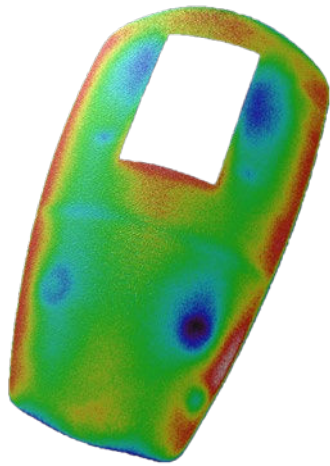

Determination of shape deviation defects on the front side of injection-molded parts caused by injection of bridges and joining elements on the rear side



Detection and evaluation of breaks on clutch discs

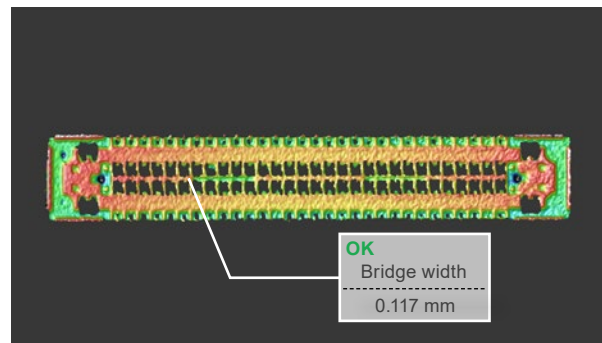

Completeness check of the bridges of a smartphone charging connector plug

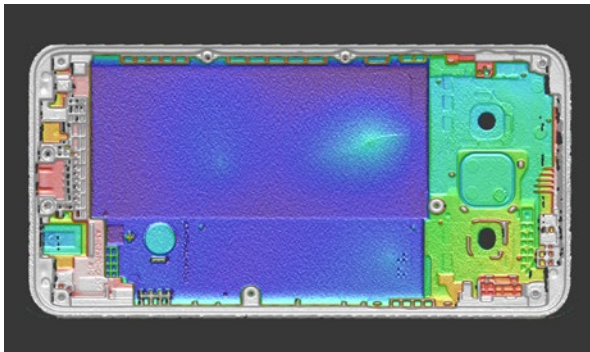

Detection of surface defects on a smartphone shell

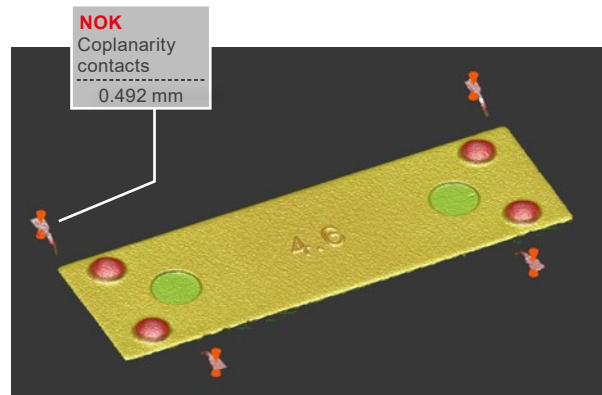

Coplanarity measurement of contacts on electrical components

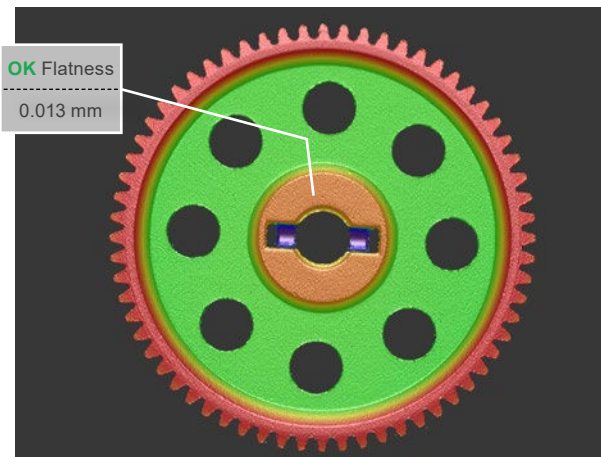

Flatness measurement of the flange of a gear wheel

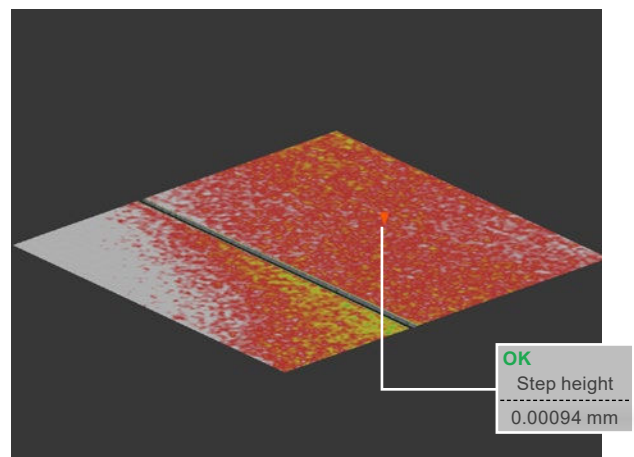

Reliable and high-precision measurement of a 1 μ m high step
Depiction of a height difference.

3D performance for industrial applications

surfaceCONTROL 3D 32x0

High repeatability up to $0.4 \mu\text{m}$

Automated inline 3D measurement for geometry, shape and surface inspections

Acquisition time from 0.3 s

Fully integrated industrial sensor (IP67) with passive cooling

Real 3D data via latest 3D GigE Vision standard

Easy integration in all common 3D image processing packets

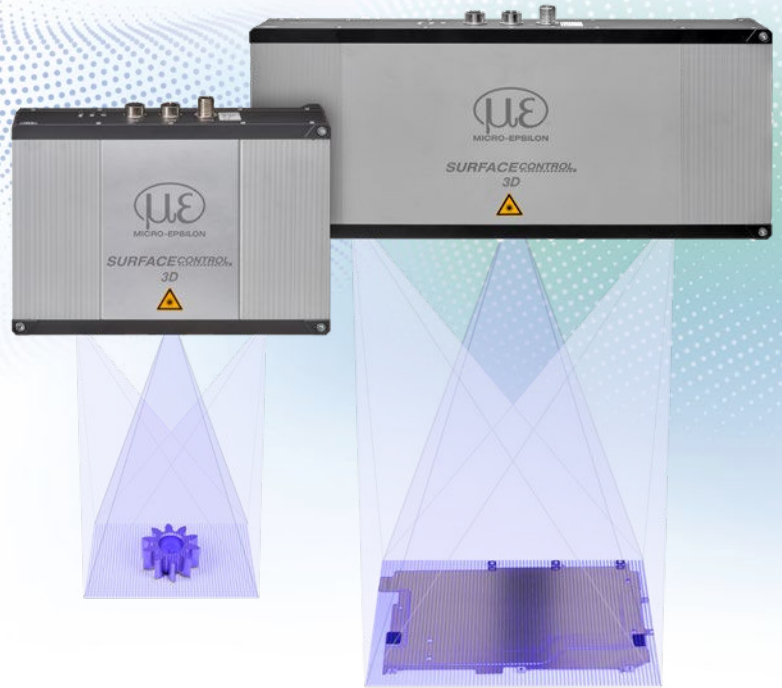

Ideal for industrial 3D applications

The surfaceCONTROL 32x0 3D sensors are ideally suited to automated inline inspection of geometry, shapes and surfaces on diffuse reflecting surfaces. The 3D snapshot sensors are characterized by their compact design and high measurement accuracy combined with high-speed data processing. With a z-axis repeatability of up to $0.4 \mu\text{m}$, the sensor sets new standards in high precision 3D metrology. This enables reliable detection of even the smallest deviations in flatness and height. Three measurement areas cover different fields of application.

New: larger measurement area with high repeatability

With a measurement area up to $230 \times 180 \text{ mm}$, the surfaceCONTROL 32x0-240 captures structures and details on larger targets with high precision. The high z-axis resolution of $5 \mu\text{m}$ in combination with the larger measurement area enables maximum precision for a wide range of applications, e.g., for testing bipolar plates.

New: high-precision sensor for the smallest measuring objects

With its small measurement area of $30 \times 18.5 \text{ mm}$, the surfaceCONTROL 32x0-30 detects even the finest 3D and surface structures with utmost precision and reliability. Thanks to the high z-axis resolution and an xy resolution from $25 \mu\text{m}$ combined with precise repeatability, even more accurate detection is possible.

3DInspect functional extension

The surfaceCONTROL 32x0 series is available with the 3DInspect functional extension. For connection to an automation interface, the 3DInspect Automation function extension is enabled with use of the SC3210 sensors, which also includes comprehensive data logging.

Article designation

SC	32	00	-80
			Measuring range 30 mm 80 mm 120 mm 240 mm
			Class 00 = Standard 10 = Functional extension
			Series 32x0

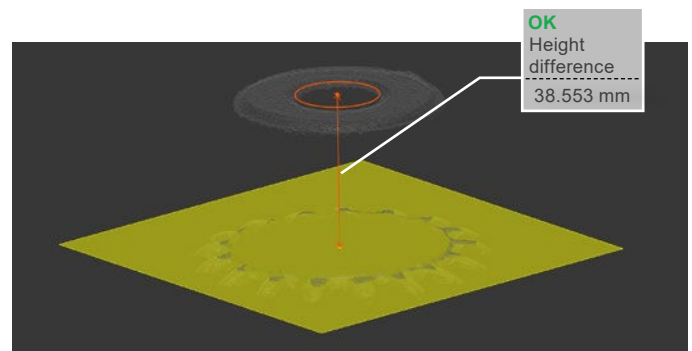

Height difference measurement of the bore in a gear wheel

Model		SC3200-30	SC3210-30	SC3200-80	SC3210-80	SC3200-120	SC3210-120	SC3200-240	SC3210-240
Measurement area Length (x) * width (y) at distance (z)	Start of expanded area	26.5 x 17.5 at 124 mm		50 x 44 at 110 mm		78 x 62 at 171 mm		135 x 115 at 340 mm	
	Start	29.5 x 18 at 127 mm		65 x 47 at 120 mm		100 x 70 at 191 mm		180 x 130 at 380 mm	
	Mid	30 x 18.5 at 130 mm		75 x 50 at 130 mm		115 x 75 at 206 mm		235 x 150 at 440 mm	
	End	30.5 x 19 at 133 mm		74 x 53 at 140 mm		115 x 79 at 221 mm		235 x 170 at 500 mm	
	End of expanded area	29.5 x 19.5 at 136 mm		70 x 56 at 150 mm		113 x 85 at 241 mm		230 x 180 at 540 mm	
Working distance	z	130 ±3 mm		130 ±10 mm		206 ±15 mm		440 ±60 mm	
	extended z	130 ±6 mm		130 ±20 mm		206 ±35 mm		440 ±100 mm	
Resolution	x,y	25 ... 27 μm		55 ... 70 μm		80 ... 100 μm		160 ... 210 μm	
	z ¹⁾	1.0 μm		1.5 μm		3.4 μm		5.0 μm	
Repeatability	z(σ) ¹⁾	< 0.4 μm		< 0.6 μm		< 1.2 μm		< 1.8 μm	
Acquisition time ^{2) 3)}		0.3 ... 0.7 s							
Light source		LED							
Supply voltage		24 VDC ±20%							
Max. current consumption		0.5 ... 1.5 A							
Digital interfaces		Gigabit Ethernet (GigE Vision / GenICam)/ PROFINET ⁴⁾ / EtherCAT ⁴⁾ / EtherNet/IP ⁴⁾							
Digital in-/outputs		4 digital I/Os for which parameters can be set (for external trigger, sensor control, output of sensor states)							
Connection		8-pin M12 socket for Gigabit Ethernet, 12-pin M12 socket for digital I/Os, 4-pin M12 plug for power supply							
Installation		3 mounting holes (installation can be reproduced with centering sleeves)							
Temperature range	Storage	-20 °C ... +70 °C							
	Operation ⁵⁾	0 °C ... +45 °C						0 °C ... +40 °C	
Shock (DIN EN 60068-2-27)		15 g / 6 ms in XY axis, 1000 shocks each							
Vibration (DIN EN 60068-2-6)		2 g / 20 ... 500 Hz in XY axis, 10 cycles each							
Protection class (DIN EN 60529)		IP67							
Material		Aluminum housing, passive cooling, external cooling optionally available (see accessories)							
Weight		1.9 kg						2.3 kg	
Control and indicator elements		3 LEDs (for device status, power, data transmission)							
Sensor SDK		Micro-Epsilon 3D sensor SDK							
3D evaluation software		Micro-Epsilon 3DInspect							
Functional extension		-	3DInspect Automation	-	3DInspect Automation	-	3DInspect Automation	-	3DInspect Automation

¹⁾ Measured on measuring object with cooperative surface in the center of the measurement area while the EnhancedSNR parameter is enabled and a 3x3 mean value filter is used once at a consistent room temperature of (20 ± 1 °C).

²⁾ Duration that the sensor requires for the image acquisition of the pattern projections (without processing and evaluation time).

³⁾ Applies for exposure times < 6,800 μs

⁴⁾ Connection via 2D/3D gateway interface module

⁵⁾ Max. permissible operating temperature depends on installation scenario, connection and operating mode. In combination with a ventilation unit (art. no. 2105079), continuous measurement operation is possible at ambient temperatures of up to 45 °C (valid for measuring ranges 30, 80 and 120 mm).

Highest 3D performance for industrial applications

surfaceCONTROL 3D 35x0

Highest z-axis repeatability up to 0.25 μm

Automated inline 3D measurement for geometry, shape and surface inspections

Acquisition time from 0.2 s

Fully integrated industrial sensor (IP67) with passive cooling

Real 3D data via latest 3D GigE Vision standard

Easy integration in all common 3D image processing packets

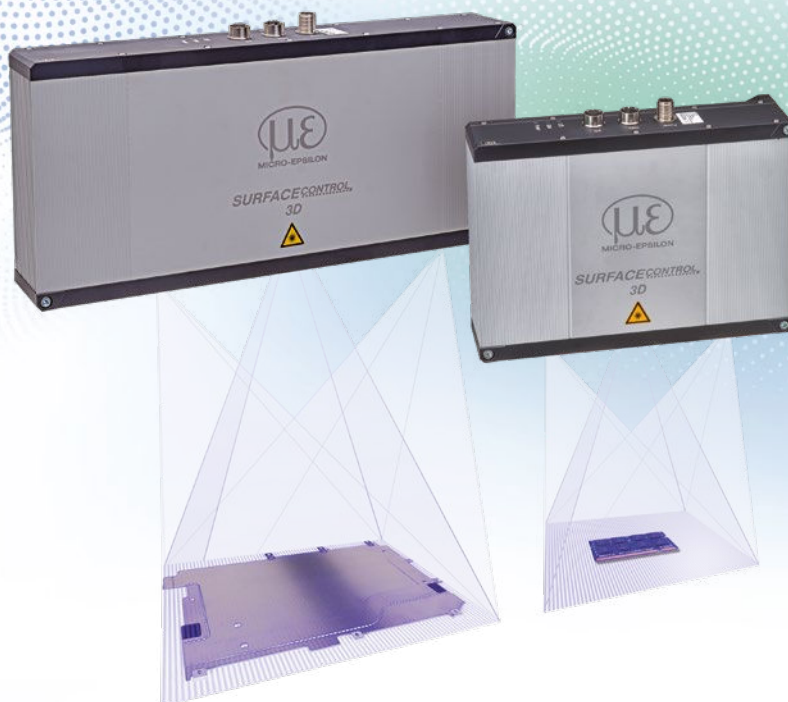

Ideal for high precision 3D measurements

The surfaceCONTROL 35x0 3D sensors are ideally suited to automated inline inspection of geometry, shapes and diffuse reflecting surfaces. The 3D snapshot sensors are characterized by their compact design and high measurement accuracy combined with high-speed data processing. With a z-axis repeatability of up to 0.25 μm , the sensor sets new standards in high precision 3D metrology. This enables reliable detection of even the smallest deviations in flatness and height. Three measurement areas cover different fields of application.

Larger measurement area with highest repeatability

With a measurement area of up to 245 x 180 mm, the surfaceCONTROL 35x0-240 captures structures and details on larger targets with highest precision. The high z-axis resolution of 4 μm in combination with the larger measurement area enables maximum precision for a wide range of applications, e.g., for testing bipolar plates.

New: high-precision sensor for the smallest measuring objects

With its small measurement area of 30 x 18.5 mm, the surfaceCONTROL 35x0-30 detects even the finest 3D and surface structures with utmost precision and reliability. Thanks to the high z-axis resolution and an xy resolution from 16 μm combined with precise repeatability, even more accurate detection is possible.

Available with the 3DInspect functional extension

The surfaceCONTROL 35x0 series is also available with the 3DInspect functional extension. For connection to an automation interface, the 3DInspect Automation function extension is enabled with use of the SC3210 sensors, which also includes comprehensive data logging.

Article designation

SC	35	00	-80
Measuring range			
30 mm			
80 mm			
120 mm			
240 mm			
Class			
00 = Standard			
10 = Functional extension			
Series			
35x0			

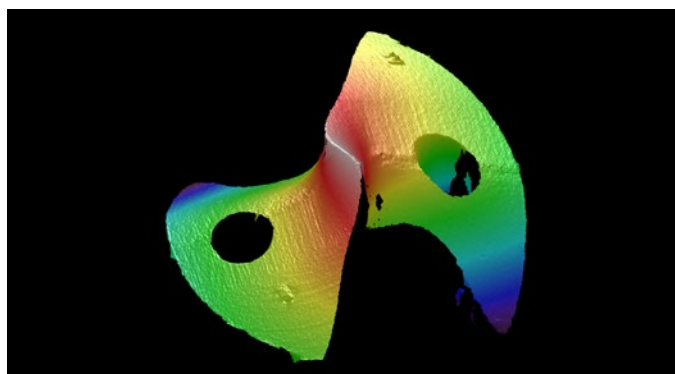

Defect detection on metal drill heads

Model		SC3500-30	SC3510-30	SC3500-80	SC3510-80	SC3500-120	SC3510-120	SC3500-240	SC3510-240
Measurement area Length (x) * width (y) at distance (z)	Start of expanded area	28 x 17.5 at 124 mm		55 x 42 at 110 mm		87.5 x 62.5 at 171 mm		145 x 115 at 340 mm	
	Start	29.5 x 18.0 at 127 mm		67.5 x 46 at 120 mm		107.5 x 70 at 191 mm		190 x 130 at 380 mm	
	Mid	30 x 18.5 at 130 mm		80 x 50 at 130 mm		120 x 75 at 206 mm		240 x 150 at 440 mm	
	End	30.5 x 19.0 at 133 mm		77.5 x 52 at 140 mm		123.5 x 80 at 221 mm		245 x 170 at 500 mm	
	End of expanded area	31.0 x 19.5 at 136 mm		75 x 54 at 150 mm		122 x 82.5 at 241 mm		245 x 180 at 540 mm	
Working distance	z	130 ±3 mm		130 ±10 mm		206 ±15 mm		440 ±60 mm	
	extended z	130 ±6 mm		130 ±20 mm		206 ±35 mm		440 ±100 mm	
Resolution	x,y	16 ... 18 μm		35 ... 45 μm		50 ... 70 μm		110 ... 140 μm	
	z ¹⁾	0.7 μm		1.0 μm		2.0 μm		4.0 μm	
Repeatability	z(σ) ¹⁾	< 0.25 μm		< 0.4 μm		< 0.7 μm		< 1.4 μm	
Acquisition time ²⁾³⁾		0.2 ... 0.4 s							
Light source		LED							
Supply voltage		24 VDC ±20 %							
Max. current consumption		0.5 ... 2.5 A							
Digital interfaces		Gigabit Ethernet (GigE Vision / GenICam) / PROFINET ⁴⁾ / EtherCAT ⁴⁾ / EtherNet/IP ⁴⁾							
Digital in-/outputs		4 digital I/Os for which parameters can be set (for external trigger, sensor control, output of sensor states)							
Connection		8-pin M12 socket for Gigabit Ethernet, 12-pin M12 socket for digital I/Os, 4-pin M12 plug for power supply							
Installation		3 mounting holes (installation can be reproduced with centering sleeves)							
Temperature range	Storage	-20 ... +70 °C							
	Operation ⁵⁾	0 ... +45 °C						0 ... +40 °C	
Shock (DIN EN 60068-2-27)		15 g / 6 ms in XY axis, 1000 shocks each							
Vibration (DIN EN 60068-2-6)		2 g / 20 ... 500 Hz in XY axis, 10 cycles each							
Protection class (DIN EN 60529)		IP67							
Material		Aluminum housing, passive cooling; external cooling optionally available (see accessories)							
Weight		1.9 kg						2.3 kg	
Control and indicator elements		3 LEDs (for device status, power, data transmission)							
Sensor SDK		Micro-Epsilon 3D sensor SDK							
3D evaluation software		Micro-Epsilon 3DInspect							
Functional extension		-	3DInspect Automation	-	3DInspect Automation	-	3DInspect Automation	-	3DInspect Automation

¹⁾ Measured on measuring object with cooperative surface in the center of the measurement area while the EnhancedSNR parameter is enabled and a 3x3 mean value filter is used once at a consistent room temperature of (20 ± 1 °C).

²⁾ Duration that the sensor requires for the image acquisition of the pattern projections (without processing and evaluation time).

³⁾ Applies for exposure times < 6,800 μs

⁴⁾ Connection via 2D/3D gateway interface module

⁵⁾ Max. permissible operating temperature depends on installation scenario, connection and operating mode. In combination with a ventilation unit (art. no. 2105079), continuous measurement operation is possible at ambient temperatures of up to 45 °C (valid for measuring ranges 30, 80 and 120 mm)

Dimensions and measurement areas

surfaceCONTROL 3D

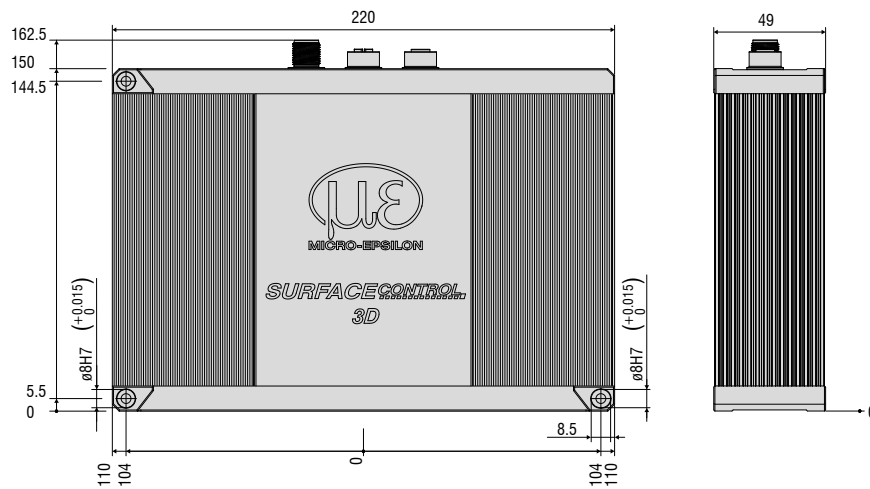

surfaceCONTROL 3D 3200

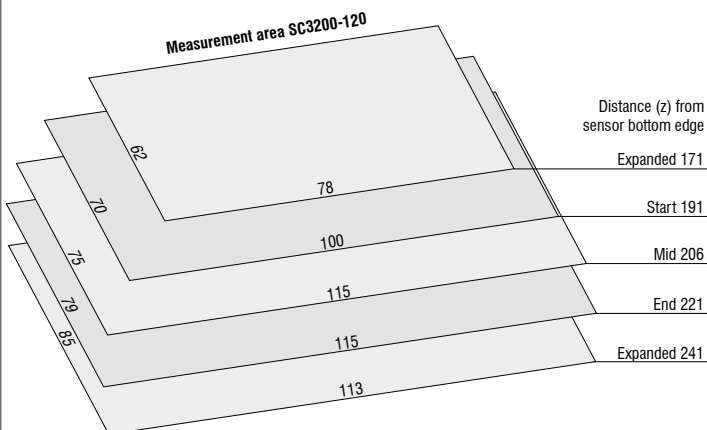
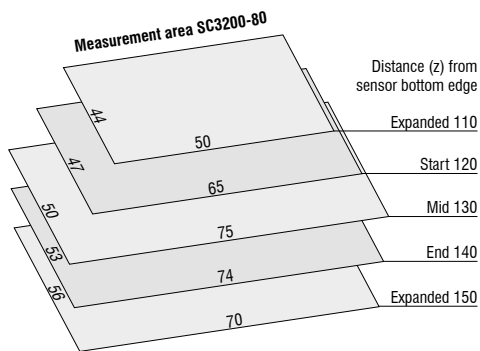
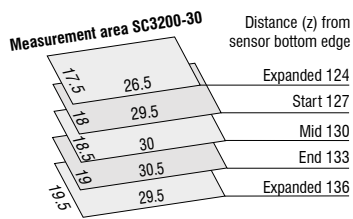

surfaceCONTROL 3D 3500

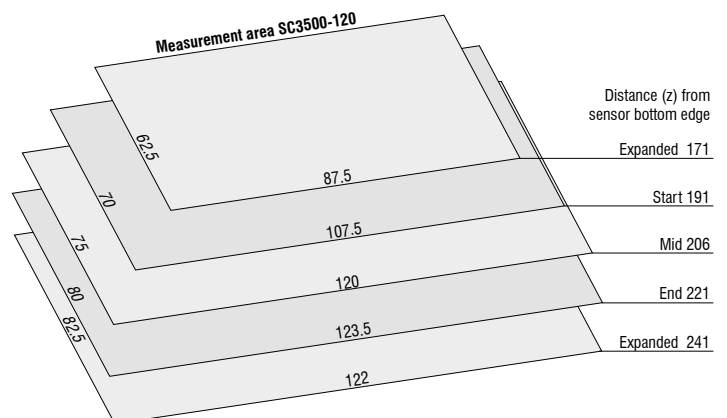
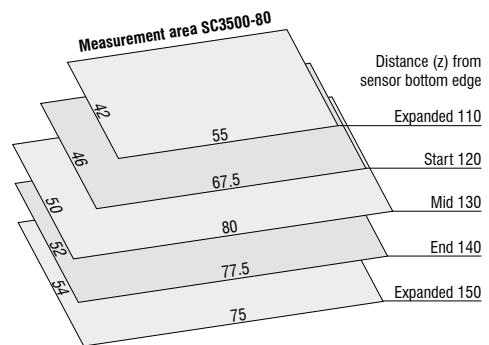
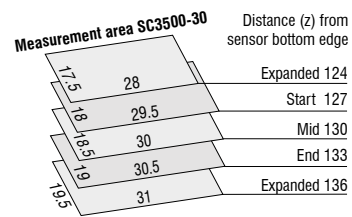

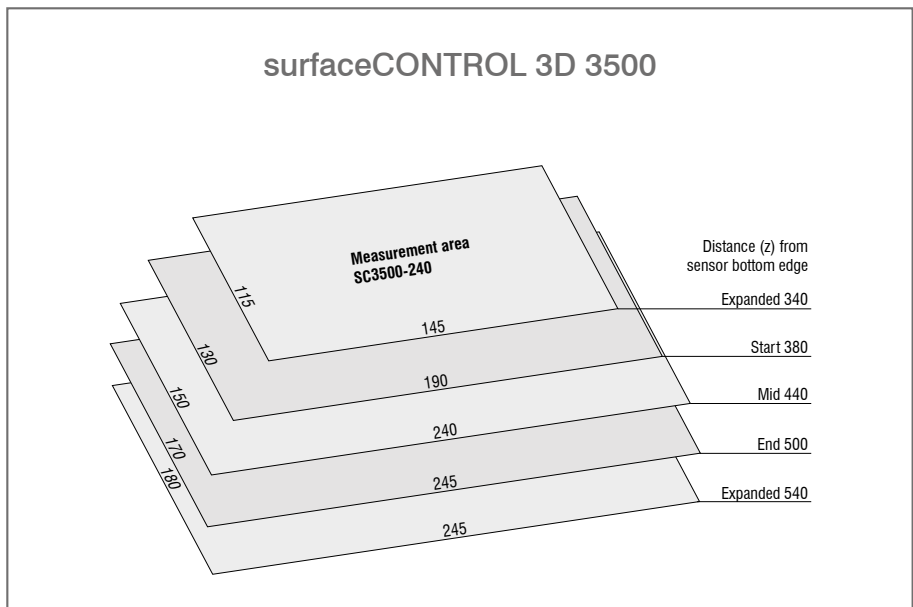
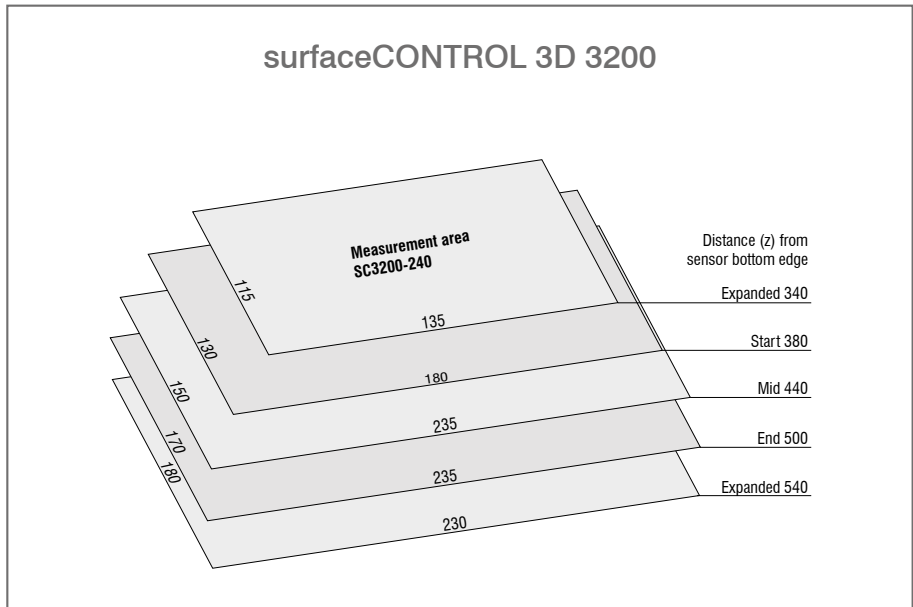
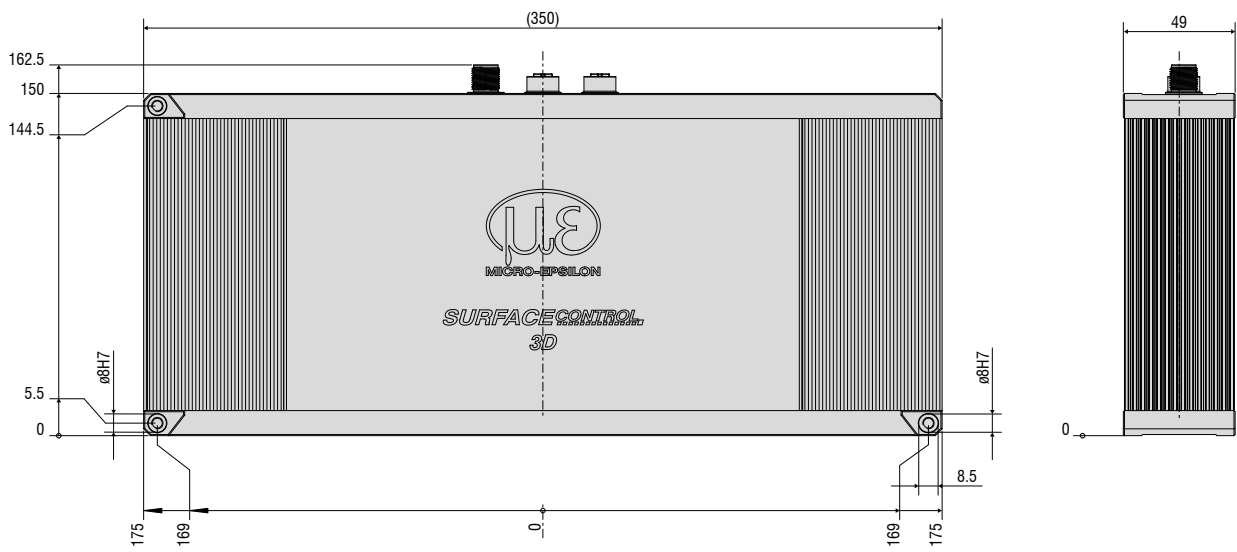

Software for 3D measurement and inspection tasks

3DInspect

Intuitive user interface

Real 3D evaluation, not just 2.5D

Automatic output of measured values for inline operation

Object extraction in 3D

Direct feedback with algorithms

Compatible with all 3D sensors from Micro-Epsilon

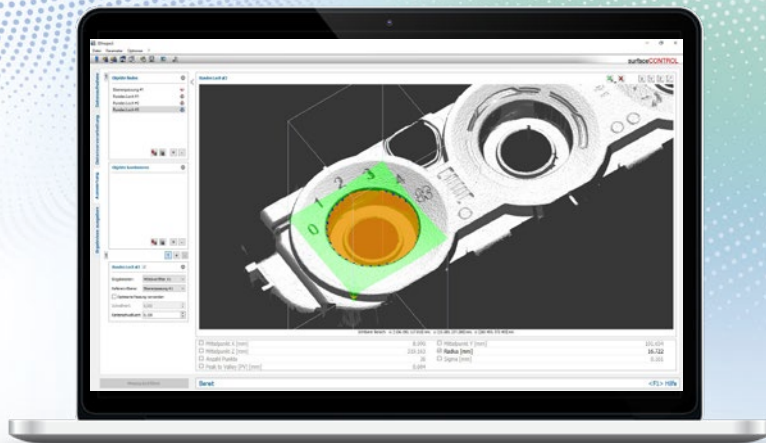

The 3DInspect software is a powerful tool for sensor parameter set up and industrial measurement tasks. This software transmits the measurement data from the sensor via Ethernet and provides the data in three-dimensional form. This 3D data is further processed, evaluated and assessed with 3DInspect measuring programs on the PC and, if necessary, logged and transmitted via Ethernet to a control unit. Furthermore, the software enables the storage of 3D data.

Valid3D technology from Micro-Epsilon vs. conventional 2.5D systems

Valid3D:
Real 3D
without
data loss

The unique Valid3D technology enables lossless display and processing of the point clouds. This is how scanned 3D objects can be moved arbitrarily in the coordinate system.

Measuring object

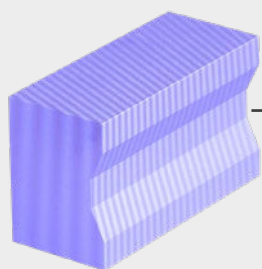

Point cloud

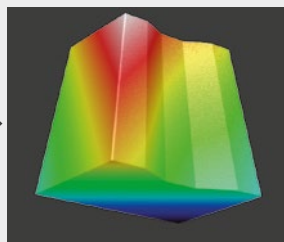

Point cloud after turn

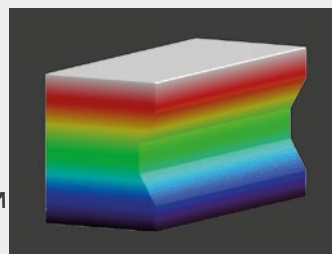

3DInspect with Valid3D

- Real 3D image of test object without data loss
- Analysis and evaluation of complete test object

Common 3D software

- Algorithms based on 2.5D
- Only one z-coordinate per x/y coordinate possible
- Data loss during data processing

Data preprocessing

With data preprocessing, the point cloud can be adjusted before evaluation. This enables, for example, the correction of moving components, so that the point cloud for the evaluation is always in the same position.

In addition, it is possible to refine the point cloud before evaluation, to apply filters to highlight features, to cut away irrelevant points or to set sections.

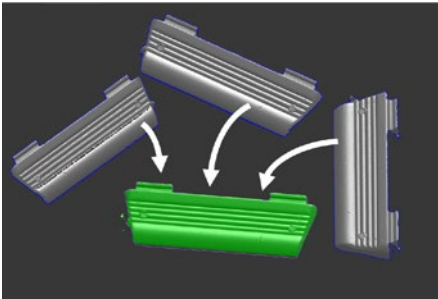
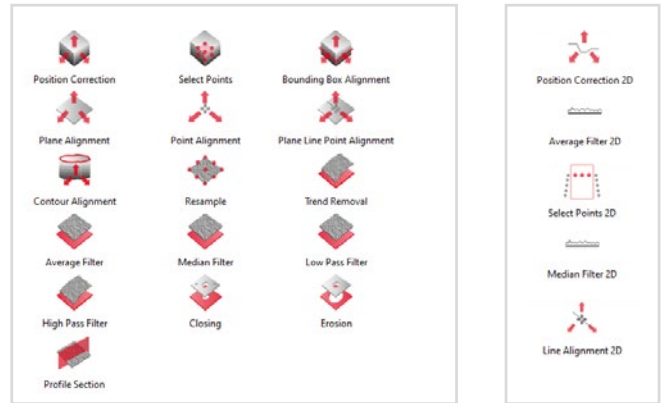

Automatic alignment of the point cloud

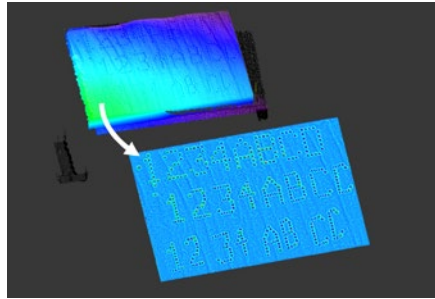

Processing of data

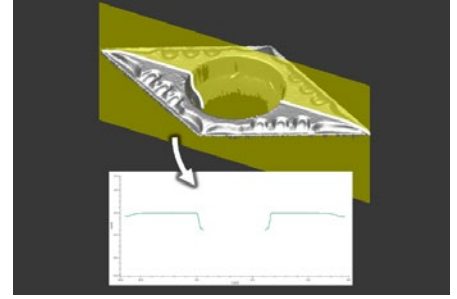

Setting cuts

Data evaluation

For data analysis, numerous programs are available to locate and measure characteristics. These can be edges, spheres or holes, for example. Both the evaluation of the 3D data, and a measurement or evaluation directly in previously generated sections is possible.

The 2D and 3D objects can also be set in relation to each other using combinations, for example to determine distances between a sphere and a plane or the angle between two edges.

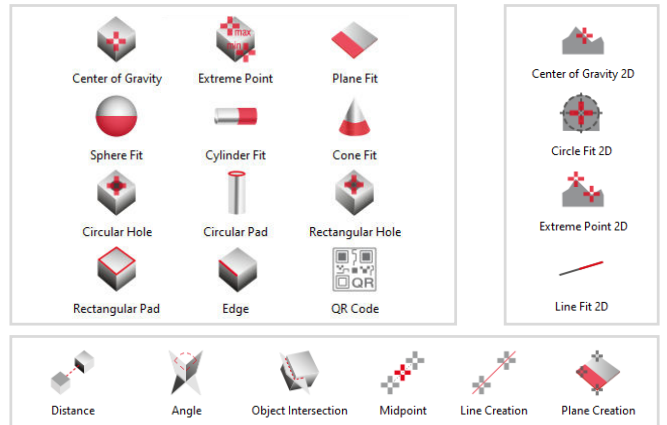

Accessories & Connection cables

Accessories for continuous cooling

A ventilation unit is available for continuous cooling of the surfaceCONTROL 3D 3500 and 3200 sensors. The ventilator is housed in an industrial-grade IP67 enclosure and is particularly quiet. The ventilation unit can be used for sensors with measuring ranges of 30, 80 and 120 mm.



Industrial Performance Unit

Powerful computer platform for 3DInspect

The Industrial Performance Unit offers integrated interfaces for connection to the industrial fieldbuses PROFINET, EtherCAT and Ethernet/IP. Prepared device description files allow easy integration into the respective control environment. For reliable communication, the sequential control model developed by Micro-Epsilon is available for smooth commissioning. It is available as an implementation example for typical controllers.

- High-performance solution for 3D measurement tasks
- Full compatibility and inline capability for customer applications
- Intuitive 3DInspect software with Valid3D technology
- Efficient commissioning of Micro-Epsilon sensors
- Industrial-grade hardware with passive cooling

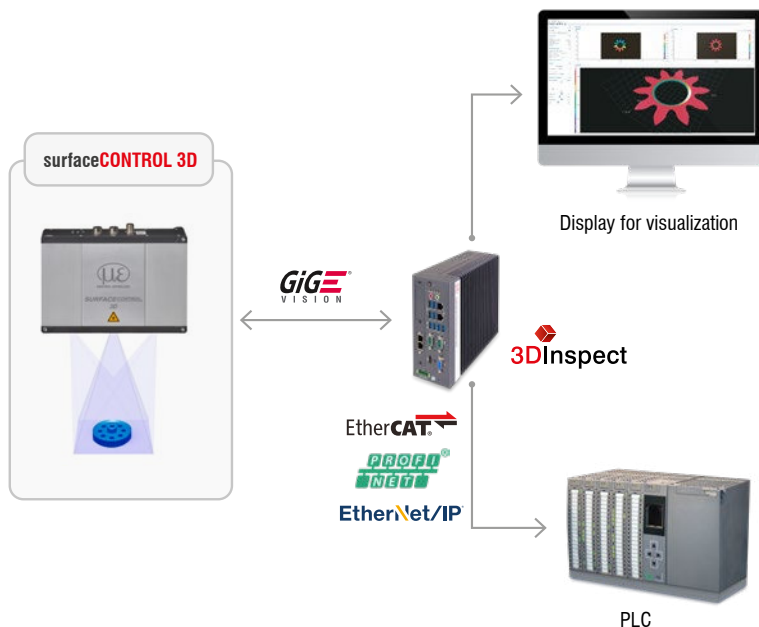

2D/3D Gateway for 3DInspect

Profinet / EtherCAT / EtherNet/IP

The 2D/3D gateway is used when the 3DInspect evaluation is running on a customer computer. Up to 4 computers with 3DInspect can be connected to one gateway. Operation of more than one computer requires a switch. The 2D/3D Gateway communicates with the computers via Ethernet Modbus TCP. The resultant values are then converted to PROFINET, EtherCAT or EtherNet/IP. The customer carries out the parameter setup with a detailed instruction manual. The gateway can also be parameterized in advance at the factory.



Models

6414142	2D/3D Gateway	Fieldbus coupler, configurable for PROFINET, EtherNet/IP and EtherCAT
6414142.001	2D/3D Gateway, pre-parameterized	Pre-parameterized to customer log and IP addresses
6414160	Industrial Performance Unit	IPC ready to use for 3DInspect in combination with all 3D sensors

Supply cable ECR3000-x

Power supply cable suitable for drag chains and robots

Cable length: 2 / 5 / 10 / 15 / 20 / 25 / 35 m

PCR3000-x Multi-function cable

Cable for power supply, digital inputs; suitable for drag chains and robots (TTL or HTL), RS422 (half-duplex)

Cable length: 2 / 5 / 10 / 15 / 20 / 25 / 35 m



Ethernet connection cable SCR3000X-x

Cable for parameter setting, value and profile transmission; suitable for drag chains and robots

Cable length: 2 / 5 / 10 / 15 / 20 / 25 / 35 m

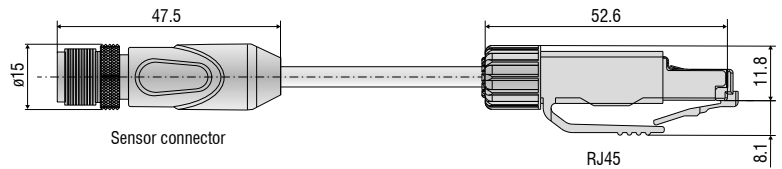

Other accessories

Art. no.	Model	Description
2420103	PS3000	Table power pack
2105079	Air cooling for surfaceCONTROL 3D	Cooling accessories for temperatures up to 45 °C
2961007	Tripod surfaceCONTROL 3D	Tripod for mounting and adjusting 3D sensors
2961008	Articulated arm for surfaceCONTROL	Articulated arm for mounting and adjusting 3D sensors
2961011	Articulated arm for surfaceCONTROL 240	Articulated arm for mounting and aligning the 240 series sensors
3007579	Adapter plate for surfaceCONTROL 3D	Mounting bracket
3008681	Adapter plate for surfaceCONTROL 240	Mounting bracket for measuring range 240 mm

Innovative 3D Technologies from Micro-Epsilon



scanCONTROL

- Precise laser line scanners for 3D point clouds
- Red laser & patented Blue Laser Technology
- Up to 2048 points per profile
- Measuring rates up to 10,000 kHz
- Numerous measuring ranges



surfaceCONTROL 2500

- Inspection of matt surfaces with high accuracy
- Large measuring fields up to 575 x 435 x 300 mm³
- Detection of different surface form defects
- Objective evaluation of the deviations
- Continuous process monitoring
- Optical error marking with back projection



reflectCONTROL Sensor

- Measurement of shiny, flat components
- Fast, full-surface inspection
- High-precision measurements, flatness deviation in the submicron range
- Large measuring field